

FX Family

MELSEC PLC

Technical Catalogue



**ALPHA /// FX1S /// FX1N /// FX2N
/// FX2NC /// FX3U ///**

Further Publications within the PLC Range

Technical Catalogues

System Q, AnSH, QnASH Technical Catalogues

Product catalogues for programmable logic controllers and accessories for the further MELSEC PLC series

Networks Technical Catalogue

Product catalogue for Master and Slave modules as well as accessories for the use of programmable logic controllers in open and MELSEC networks

HMI Technical Catalogue

Product catalogue for operator terminals, supervision software and accessories

More information?

This technical catalogue is designed to give an overview of the extensive range of FX Family of MELSEC PLCs. If you cannot find the information you require in this catalogue, there are a number of ways you can get further details on configuration and technical issues, pricing and availability.

For technical issues visit the www.mitsubishi-automation.com website.

Our website provides a simple and fast way of accessing further technical data and up to the minute details on our products and services. Manuals and catalogues are available in several different languages and can be downloaded for free.

For technical, configuration, pricing and availability issues contact our distributors and partners.

Mitsubishi partners and distributors are only too happy to help answer your technical questions or help with configuration building. For a list of Mitsubishi partners please see the back of this catalogue or alternatively take a look at the "contact us" section of our website.

About this technical catalogue

This catalogue is a guide to the range of products available. For detailed configuration rules, system building, installation and configuration the associated product manuals must be read. You must satisfy yourself that any system you design with the products in this catalogue is fit for purpose, meets your requires and conforms to the product configuration rules as defined in the product manuals.

Specifications are subject to change without notice. All trademarks acknowledged.

System Description

- ◆ ALPHA and MELSEC PLC system 4
- ◆ Extension modules and special function modules 6

1 ALPHA Controllers

- ◆ Base units 8
- ◆ Extension units and accessories 10

2 MELSEC FX Base Units

- ◆ FX1S series 13
- ◆ FX1N series 16
- ◆ FX2N series 19
- ◆ FX2NC series 23
- ◆ FX3U series 27

3 MELSEC FX Extension Units

- ◆ System configuration 29
- ◆ Powered compact extension units 30
- ◆ Unpowered modular extension blocks 32

4 MELSEC FX Special Function Modules

- ◆ Analog modules 33
- ◆ High-speed counter modules 36
- ◆ Positioning modules 37
- ◆ Network modules 39
- ◆ Communications modules 45
- ◆ Interface modules 46
- ◆ Adapter boards 46
- ◆ Interface adapters 47

5 Accessories

- ◆ Memory media 49
- ◆ Terminal blocks 50
- ◆ Connection cables, backup batteries 51
- ◆ Display modules 53

6 Terminals and Dimensions

TERMINAL LAYOUT

- ◆ Base units 54
- ◆ Extension units 63
- ◆ Special function modules 67
- ◆ Terminal blocks 74

DIMENSIONS

- ◆ Base and extension units 76
- ◆ Special function modules 80
- ◆ Accessories 81

7 Software & Programming

- ◆ Trainings and programming software 82
- ◆ Programming units and accessories 85

ALPHA and MELSEC PLC Systems

The ALPHA Series

The ALPHA closes the gap between single components and a PLC system. It combines all advantages of a PLC system in a very compact housing and therefore provides a space and cost saving alternative to relays and contactors.

The ALPHA series is suited to applications in industrial machines and in automated building services.

Key enhancements in the ALPHA2 include a program capacity of 200 function blocks, an extra-large display, expansion options and a second communications port. The instruction set, includes math operations, PWM and SMS text messaging functions. All this opens up possibilities for analog and temperature control as well as remote operation.

The MELSEC FX Family

The MELSEC FX family includes a very comprehensive range of base and expansion modules, enabling you to configure a customised system tailored to your precise requirements.

Depending on your application and control needs you can choose from the small, attractively-priced, "stand-alone" FX1S series, the expandable FX1N series or the more powerful FX2N /FX2NC and FX3U series.

With the exception of the FX1S all FX series can be expanded to adapt them to the changing needs of your installations and applications.

Network integration is also supported, making it possible for your FX controllers to communicate with other PLCs, controllers and HMIs. The PLC systems can be configured as local stations in MITSUBISHI networks. In addition these flexible units can also be used as master or slave units on fieldbus's like Profibus/DP and CC-Link.

The MELSEC FX Family controllers also support CANopen, DeviceNet and Ethernet.

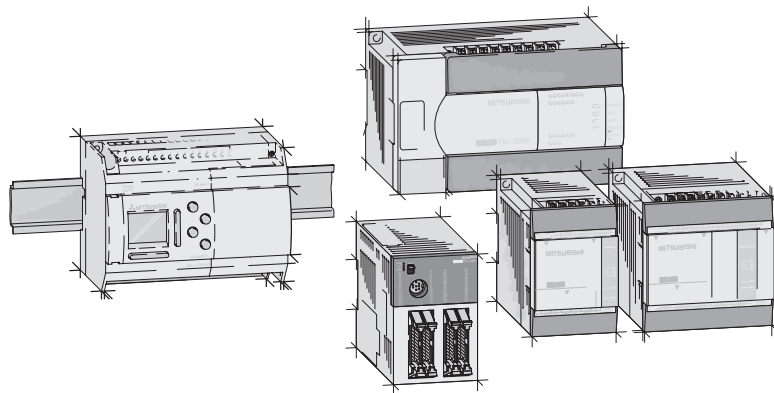

Expandability and Power

The MELSEC FX family is highly flexible, enabling fast and efficient configuration and programming for the application at hand.

It is the ideal choice, no matter whether you need to install a simple control application requiring 10 I/Os (FX1S) or a demanding, complex system with up to 384 I/O points (FX3U).

The use of memory cassettes can expand the available programming space on some FX Family PLCs while generally providing a long term program storage option for all FX PLC users. In addition, memory cassettes can also allow programs to be switched at very short notice simply by replacing the cassette.

There are five series in the MELSEC FX family, each of which is designed for a different application profile:

● The FX1S Series

The MELSEC FX1S series is the inexpensive entry to the MELSEC FX family. With its small dimensions it is also an excellent alternative to relay/contactors control configurations.

● The FX1N Series

The CPUs of the FX1N series offer more power than the FX1S series, plus modular expansion capabilities. You can choose from I/O expansion modules and special function modules for a wide variety of applications.

● The FX2N Series

The FX2N series complements the existing FX family. It gives you the freedom of modular expandability, with a wide selection of expansion modules and special function modules.

The FX2N is also one of the fastest PLC systems available, with a cycle time of 0.08 µs per logical instruction.

● The FX2NC Series

The performance of the FX2NC is the same as that of the FX2N series, but it has more compact dimensions. It is the ideal choice for applications where little space is available for the controller.

● The FX3U Series

The FX3U series is the newest member of the FX family. It gives you the freedom of modular expandability, with a wide selection of expansion modules and special function modules.

The FX3U is the fastest PLC systems available, with a cycle time of just 0.065 µs per logical instruction. This gives users a powerful CPU delivering modular PLC performance in a compact PLC design.

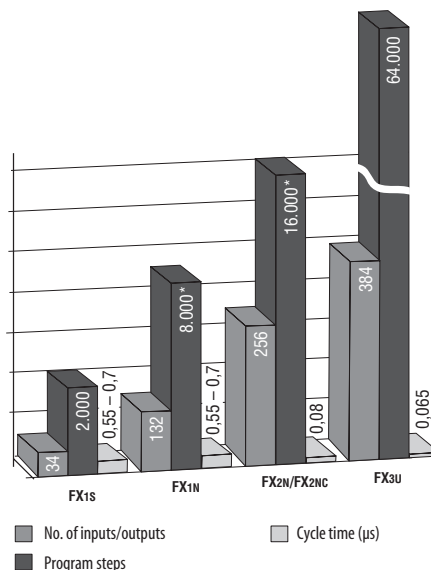

*Max. memory capacity (achieved by optional memory cassettes.)

Features

The modular design of the FX family makes it extremely flexible, enabling it to be used for a very broad range of applications. You can configure tailor-made systems by combining modules from a variety of different categories (see figure).

All modules are electrically isolated from their environment with optocouplers for maximum reliability.

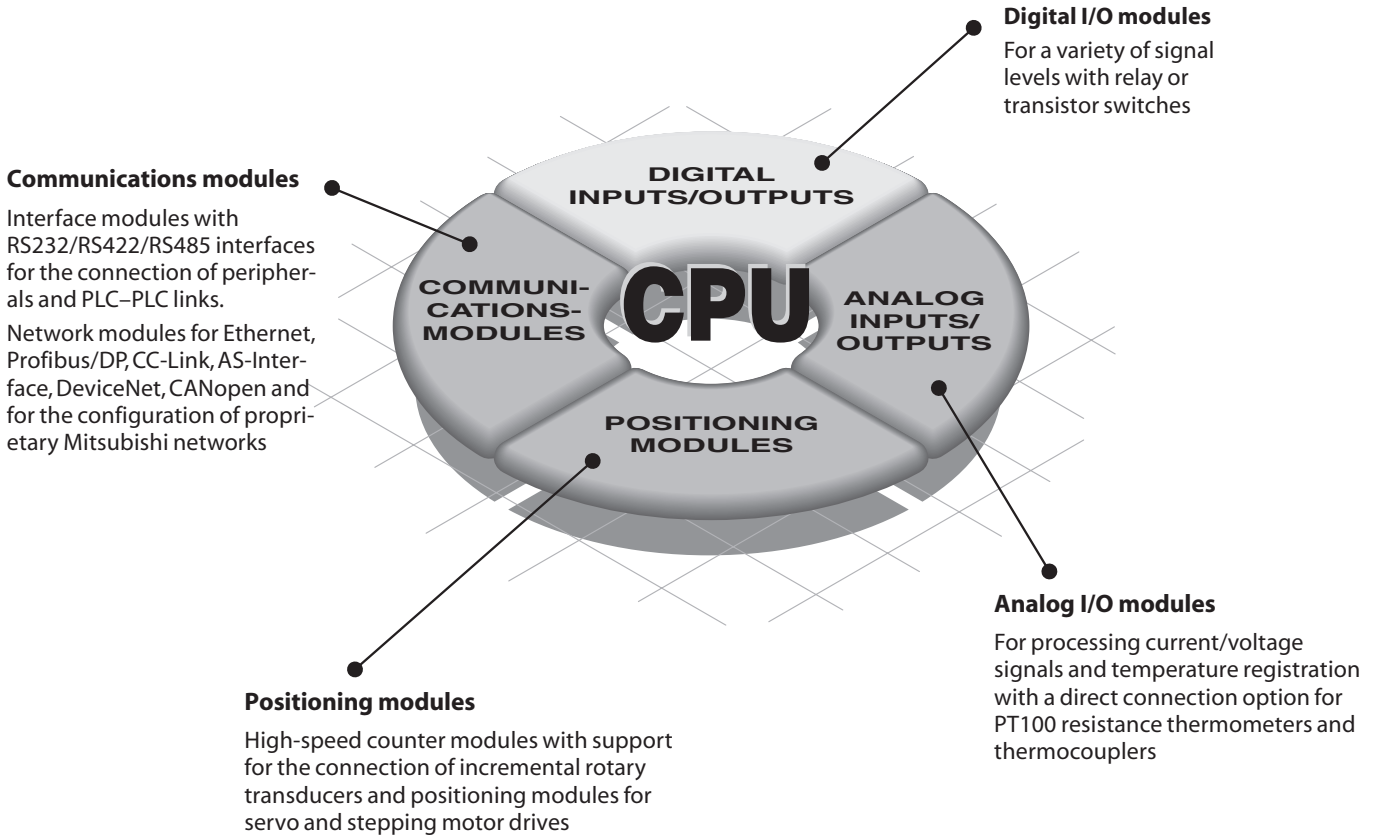

Digital and special function modules – configuration

The options for using digital and special function modules are dictated by the CPU used in the system.

When calculating the number of special function modules you can use in a system you must take both the number of digital modules and the maximum number of special function modules that can be used into account.

The table on the right provides a simplified guide to the number of modules you can use in each system type. More detailed information and the basic principles of system configuration can be found in the corresponding manuals.

CPU type	System restrictions
FX1S	Stand-alone PLC with 10 / 14 / 20 or 30 I/Os; no special function modules but 1 I/O adapter board can be installed
FX1N	PLC with max. 132 I/Os A maximum of 2 special function modules or digital expansion modules with up to 32 inputs and outputs (4 x 8 I/Os or 2 x 16 I/Os) or one special function module and one digital extension module with up to 16 inputs and outputs (2 x 8 I/Os or 1 x 16 I/Os) can be connected.
FX2N	PLC with max. 256 I/Os A maximum of 8 special function modules or digital extension modules with up to 256 I/Os can be connected.
FX2NC	PLC with max. 256 I/Os A maximum of 4 special function modules or digital extension modules with up to 256 I/Os can be connected.
FX3U	PLC with max. 384 I/Os To the left side of the main unit, a maximum of 10 special adapters from the FX3U series can be connected. To the right side of the main unit, up to 8 special function modules of the FX2N series and digital extension modules with up to 256 I/Os can be connected.

The Components for an FX PLC System

A basic FX PLC system can consist of a stand alone base unit, with the functionality and I/O range increased by adding extension I/O and special function modules. The following section provides an overview of options available.

Base Units

The entire FX PLC range can be AC or DC powered with a mix of input and output styles. The PLCs can be programmed with the user friendly GX or GX IEC Developer programming software, allowing programs to be transferred between different FX PLCs. All PLC base units include an integrated real time clock.

Base units are available with different I/O configurations from 10 to 128 points but can be expanded to 384 points depending upon the FX range selected.

Extension Boards

Extension adapter boards can be installed directly into the base unit and therefore do not require any additional installation space. For a small number of I/O (2 to 4) an extension adapter boards can be installed directly into the (left-hand side) FX1S or FX1N controller. Interface adapter boards can also provide the FX PLC with additional RS232 or RS485 interfaces. To connect special function modules (e.g. Ethernet module) a communication adapter has to be installed.

Extension I/O Modules

Unpowered and powered extension I/O modules can be added to the FX1N/FX2N and FX3U PLCs. For expansion modules powered by the base unit, the power consumption has to be calculated as the 5 V DC bus can only support a limited number

of expansion I/O (for further details please refer to next page – calculation of the power consumption).

Special Function Modules

A wide variety of special function modules are available for the FX1N, FX2N and FX3U PLCs. They cover networking functionality, analog control, pulse train outputs and temperature inputs.

Peripherals

Each FX PLC has options for memory cassettes, hand held programming units as well as connection to HMI and GOT interfaces.

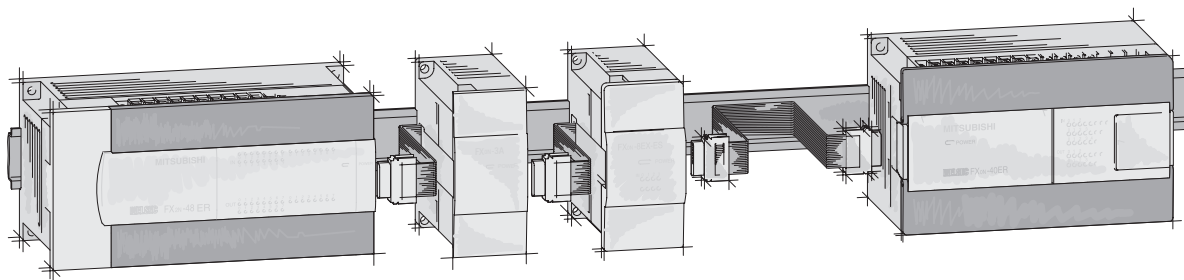

Expansion possibilities		ALPHA	FX1S	FX1N	FX2N	FX2NC	FX3U	Reference page
Extensions for inside PLC installation	Digital	●	●	●	●	—	●	11, 46
	Analog	●	●	●	●	—	●	11, 46
Extension modules (installation outside the PLC)	Digital	—	—	●	●	●	●	29
	Analog	—	—	●	●	●	●	33
	Temperature	●	—	●	●	●	●	11, 34
Network modules	AS-Interface	●	—	●	●	●	●	12, 39
	CC-Link	—	—	●	●	●	●	38
	CAN open	—	—	●	●	●	●	43
	Ethernet	—	—	●	●	●	●	40
	Profibus/DP	—	—	●	●	●	●	41
	DeviceNet	—	—	—	●	●	●	43
Communications boards	RS232	●	●	●	●	—	●	48
	RS422	—	●	●	●	—	●	48
	USB	—	—	—	—	—	●	47
Communications modules	RS232	—	—	●	●	●	●	45
	RS422	—	—	—	—	—	—	—
	RS485	—	—	●	●	●	●	44
Dedicated function modules	High speed counter	—	—	—	●	●	●	36
	Positioning	—	—	—	●	●	●	37
Memory	●	●	●	●	●	●	●	12, 49
External Display	—	●	●	●	—	—	●	53

Calculation of the Power Consumption

The power consumption figures on the 5 V DC bus for the special function modules are shown in the specifications tables on the following pages.

The maximum permissible currents on the 5 V DC bus are shown in the table below.

Modules	Max. current on 5 V bus
FX2N-□□M□-ES(ESS)	290 mA
FX2N-□□E□-ES(ESS)	690 mA
FX3U-□□MR/ES	500 mA

The residual currents for the 24 V DC service voltage at different input/output configurations are shown in the tables on the right.

Special function modules have to be supplied externally, if the residual current for the service voltage is not satisfying.

A maximum of 256 I/Os is possible.

Max.residual current values (in mA) for FX2N-16M□-E□□ through FX2N-32M□-E□□, FX2N-32E□-E□□ for the permissible configuration

Number of additional outputs	24	25							
	16	100	50	0					
	8	175	125	75	25				
	0	250	200	150	100	50			
	0	8	16	24	32				
Number of additional inputs									

Max.residual current values (in mA) for FX2N-48M□-E□□ through FX2N-128M□-E□□, FX2N-48E□-E□□ for the permissible configuration

Number of additional outputs	48	10								
	40	85	35							
	32	160	110	60	10					
	24	235	185	135	85	35				
	16	310	260	210	160	110	60	10		
	8	385	335	285	235	185	135	85	35	
	0	460	410	360	310	260	210	160	110	60
	0	8	16	24	32	40	48	56	64	
Number of additional inputs										

Sample Calculations

The tables below and on the right show different examples for sample power calculation for a PLC system.

The current values for the special function modules can be found in the specifications on the following pages.

Comparison with the current value tables show that the calculated figures for the 5 V bus lie within the allowable ranges.

In the example below all units can be supplied sufficiently with the internal 24 V power supply.

Module	No.	24 V DC calculation		5 V DC calculation	
		Current / module	Calculation	Current / module	Total current
FX2N-80MR-ES	1	460 mA	+460 mA	+290 mA	+290 mA
FX2N-4AD	3	50 mA	-150 mA	30 mA	-90 mA
FX2N-4DA	2	200 mA	-400 mA	30 mA	-60 mA
FX2N-232IF	1	80 mA	-80 mA	40 mA	-40 mA
			-170 mA !!!		290 - 190 mA
				Result:	100 mA (OK!)

An external 24 V power supply has to be added in the example above.

Module	No.	Number of I/Os			24 V DC calculation		5 V DC calculation		
		X	Y	X/Y	Total ^①	Total current ^②	Current / module	Total current	
FX2N-48MR-ES/UL	1	24	24	—	X = 8 Y = 24 →	+185 mA	290 mA	+290 mA	
FX2N-16EYR-ES/UL	1	—	16	—			—	0 mA	
FX2N-8EX-ES/UL	1	8	—	—			—	0 mA	
FX2N-8EYR-ES/UL	1	—	8	—			—	0 mA	
FXON-3A	1	—	—	8			-90 mA	30 mA	-30 mA
						+95 mA (OK!)		+260 mA (OK!)	
FX2N-32ER-ES/UL	1	16	16	—	X = 16 Y = 0 →	+150 mA	690 mA	+690 mA	
FX2N-16EX-ES/UL	1	16	—	—			—	0 mA	
FX2N-4AD	1	—	—	8			50 mA	30 mA	-30 mA
FX2N-1HC	1	—	—	8			0 mA	90 mA	-90 mA
Result:		64 + 64 + 24 = 152 ! (< 256) OK!				+100 mA (OK!)		+570 mA (OK!)	

① Total no. of I/Os which are connected to a base unit to calculate the max. residual current values (see tables) ② see tables above (max. residual current values)

The ALPHA 2 Series

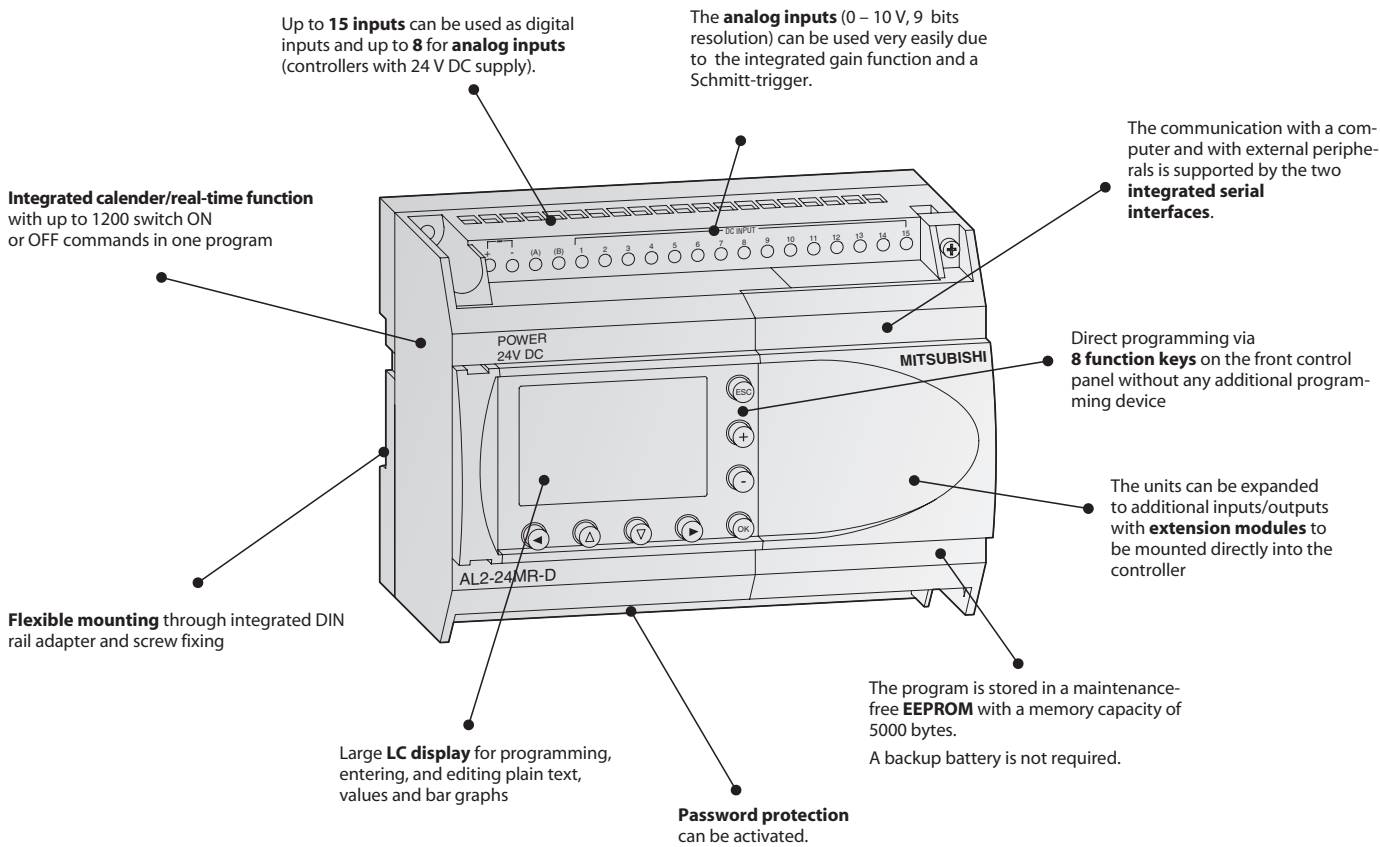

Description of the Unit Components

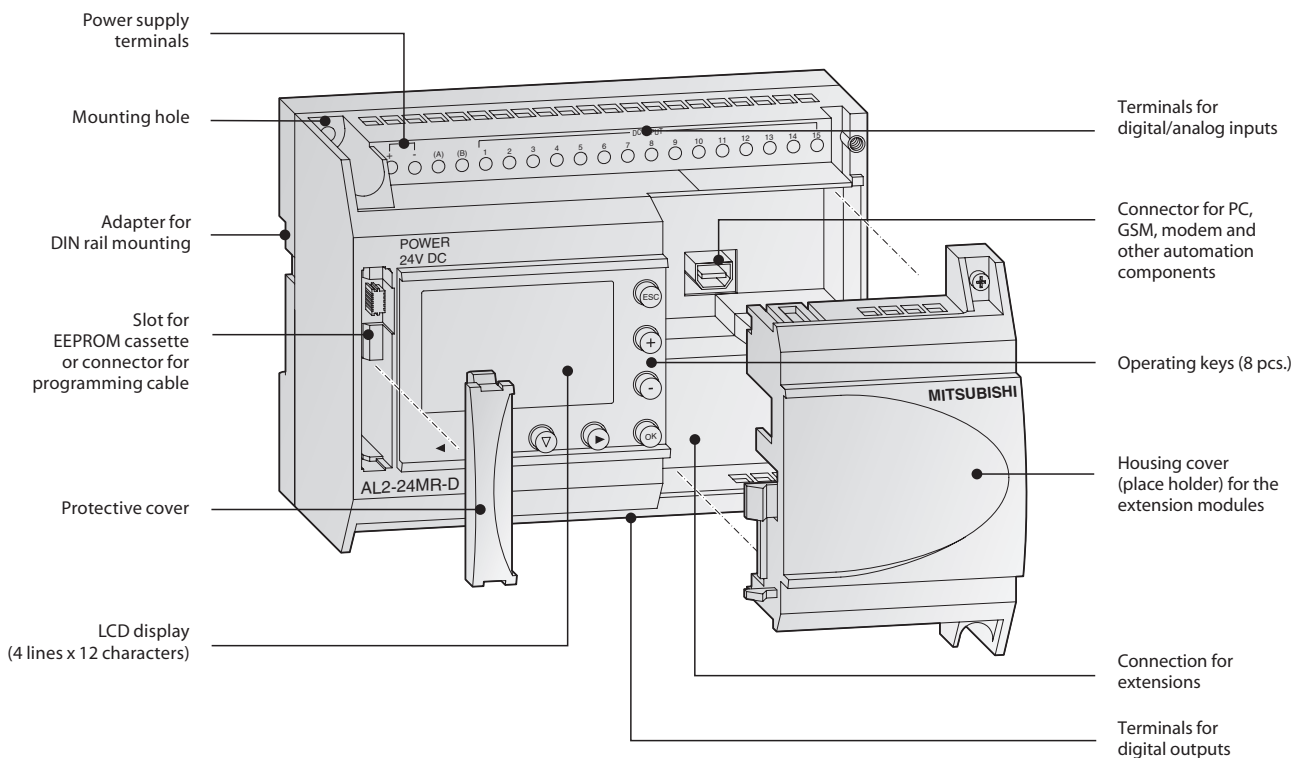

■ Specifications ALPHA 2

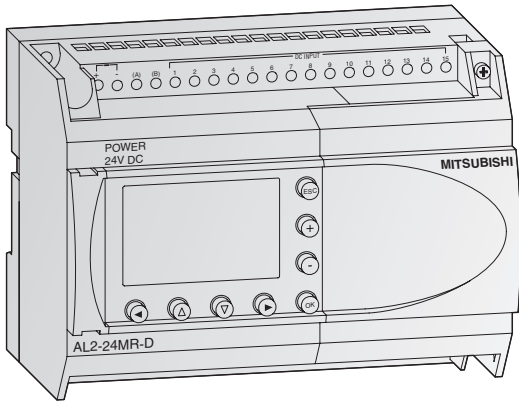

e.g. AL2-24M□-□

ALPHA 2 Base Units

The ALPHA 2 controllers offer simple reliable control for a range of automation applications including lighting, air conditioning, security systems, and temperature and water control.

Special features:

- Transistor and relay output options
- Analog input/output
- High Speed counters up to 1 kHz
- GSM function for communication with mobile phones
- Language support for 8 different languages
- Display unit for messages and function block data

Base Units with 10 – 24 I/Os

Specifications		AL2-10MR-A	AL2-10MR-D	AL2-14MR-A	AL2-14MR-D	AL2-24MR-A	AL2-24MR-D
Electrical specifications							
Integrated inputs/outputs		10	10	14	14	24	24
Digital inputs		6	6	8	8	15	15
Analog inputs		—	6	—	8	—	8
Channels		—	6	—	8	—	8
Integrated outputs		4	4	6	6	9	9
Max. power consumption	W	4.9	4.0	5.5	7.5	7.0	9.0
Typ. power consumption	All I/Os ON /OFF	3.5/1.85 240 V AC 3.0/1.55 120 V AC	2.5/0.75	4.5/2.0 240 V AC 3.5/1.5 120 V AC	4.0 / 1.0	5.5/2.5 240 V AC 4.5/2.0 120 V AC	5.0 / 1.0
Weight	kg	0.2	0.2	0.3	0.3	0.35	0.3
Dimensions (W x H x D)	mm	71.2 x 90 x 55	71.2 x 90 x 55	124.6 x 90 x 52	124.6 x 90 x 52	124.6 x 90 x 52	124.6 x 90 x 52
Order information	Art. no.	163515	163516	164867	164868	164869	164870
Accessories	Power supply ALPHA POWER 24-1.5 for DIN rail mounting, for DC supply of all 24 V DC modules, art. no.: 149046; IP40 mounting frame AL-FRAME-20-IP40, art. no.: 132333; IP54 mounting frame AL-FRAME-20-IP54, art. no.: 132337						

Environmental Specifications

General specifications	Alpha 2 series	
Ambient temperature	Display: -10 – 55 °C, Hardware: -25 – 55 °C (storage temperature: -30 – +70 °C)	
Protection rating	IP 20	
Noise immunity	1000 Vpp with noise generator; 1 µs at 30 – 100 Hz, tested by noise simulator	
Dielectric withstand voltage	3750 V AC, >1 min. according to EN60730	
Allowable relative humidity	35 – 85 % (no condensation)	
Shock resistance	Acc. to IEC 68-2-27: 147 m/s ² acceleration, 11 ms 3 x 3 directions	
Vibration resistance	direct mounting	Acc. to IEC-2-6: 19,6 m/s ² acceleration, 80 min. in each direction
	DIN rail mounting	Acc. to IEC-2-6: 9.8 m/s ² acceleration, 80 min. in each direction
Insulation resistance	500 V DC, 7 MΩ acc. to EN60730-1	
Ambient conditions	No corrosive gases, no dust	
Certifications	Please refer to page 86 in this catalogue	

Electrical Specifications

Power supply specifications	DC powered modules (AL2-□MR-D)	AC powered modules (AL2-□MR-A)
Power supply	24 V DC	100 – 240 V AC (50/60 Hz)
Inrush current at ON	≤7.0 A (at 24 V DC)	≤6.5 A (at 240 V AC)
Allowable momentary power failure time	5 ms	10 ms

Digital Inputs

Input voltage	24 V DC (+20% / -15%)	100 – 240 V AC (+10% / -15%), 50/60 Hz
Input current	The input current changes depending on Source or Sink. For Sink: (AL2-10/14/24MR-D) = 5.5 mA, 24 V DC For Source: (AL2-10/14MR-D) = 6.0 mA, 24VDC (AL2-24MR-D) = 5.5 mA, 24 V DC	101 – 108 0.13 mA / 120 V AC* 0.25 mA / 240 V AC* 109 – 115 0.15 mA / 120 V AC* 0.29 mA / 240 V AC*
Response time	OFF→ON ms	10 – 20
	ON→OFF ms	10 – 20

Analog Inputs

Analog input range	0–500	—
Resolution	9 bit, (10 V/500)	—
Conversion speed	ms	8
Voltage	0–10 V DC	—
Impedance	kΩ	142 ±5 %
Accuracy		±5 % (0.5 V DC)

* Current leakage from the sensors connected to the inputs might provide enough current to turn the controller On. Do not use two wire sensors

Output specifications	All modules
Type	Relay
Switching voltage (max.)	V 250 V AC, 30 V DC
Rated current	10M, 14M: 8 A/point 24M (001-004): 8 A/point 24M (005-009): 2 A/point
Max. switching load - inductive load	14M, 24M: 249 VA, 250 V AC/373 VA, 250 V AC 24M: 93 VA, 125 V AC/93 VA, 250 V AC
Minimum load	10 mA, 5 V DC
Response time	ms ≤10

Programming Specifications

System specifications	Alpha 2 series
Programming method	Function block
Program capacity	200 function blocks or 5000 bytes
Program processing	Cyclic processing of the stored program
Number of available instructions	38 different function blocks
Program storage	Integrated EEPROM and optional additional EEPROM cassette
Data storage	At voltage loss the current status of values, running time meters, and real-time data are stored for up to 20 days (at temperatures of 0 to 25 °C) through integrated capacitors
Processing time	1 ms + 20 µs / log. instruction (complex commands 500 µs / instruction)
Real-time clock	Seconds, minutes, hours, day of week, month, year (4-digit); accuracy: 5 s / day; automatic summer and winter time toggling
Program protection	Program and keys (3 levels)

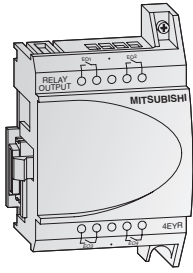

Digital Extension Modules

There are 4 different extension modules available for the ALPHA 2, which allow the controller to be extended through additional inputs or outputs. The modules are inserted directly into the ALPHA 2 and therefore do not take up any additional space.

The AL2-4EX has the additional feature that 2 inputs may be used as high-speed counters with a counting frequency of 1 kHz.

All modules feature photocoupler insulation for all I/Os.

Note: The digital extension modules cannot be used with the AL2-10MR series.

Digital extension modules specifications	AL2-4EX-A2	AL2-4EX	AL2-4EYR	AL2-4EYT
Inputs				
Integrated inputs	4	4	—	—
Input voltage	220–240 V AC	24 V DC (+20%, -15%)	—	—
Input current	7.5 mA at 240 V AC (50 Hz), 9.0 mA at 240 V AC (60 Hz)	5.4 mA ±1 mA at 24 V DC	—	—
Outputs				
Integrated outputs	—	—	4	4
Output type	—	—	Relay	Transistor
Switched voltage (max.)	V	—	250 V AC, 30 V DC	5–24 V DC
Rated current	A	—	2 A per output	1 A per output
Electrical specifications				
Power Supply	AC range (+10 %, -15 %)	220–240 V AC	24 V DC	100–240 V AC
Mechanical specifications				
Weight	kg	0.05	0.05	0.05
Dimensions (W x H x D)	mm	53.1 x 90 x 24.5	53.1 x 90 x 24.5	53.1 x 90 x 24.5
Order information				
Art. no.	142522	142521	142523	142524

Note: EI1 and EI2 of the AL2-4EX can be used as high-speed counter inputs. In each case the response time for the high-speed counter inputs will be 0.5 ms or less.

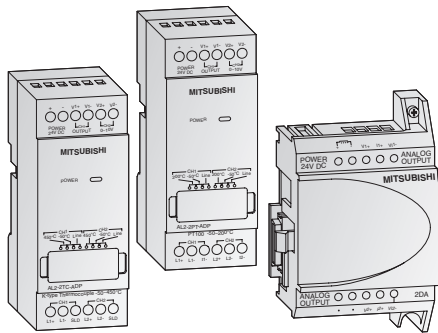

Analog Extension Modules

The analog extension modules significantly increase the range of applications for the ALPHA 2. With these modules it is possible to output voltage or current signals or to measure temperatures.

Three different analog extension modules are available:

- The AL2-2DA offers two additional analog outputs for the ALPHA 2 and converts a digital input value into a voltage or a current. This module is inserted directly into the ALPHA 2.
Note: the AL2-2DA cannot be used with the AL2-10MR series.
- The AL2-2PT-ADP connects an external PT100 sensor to convert temperature readings into analog signals (0 – 10 V).
- The AL2-2TC-ADP connects thermocouple sensors (K type) to convert temperature readings into analog signals (0 – 10 V).

Analog extension modules specifications	AL2-2DA	AL2-2PT-ADP	AL2-2TC-ADP
Analog inputs			
Integrated inputs	—	2	2
Connectable temperature sensors	—	PT100 sensor Temp. coefficient 3.850 ppm/°C (IEC 751)	Thermocouple (K type), isolated type (IEC 584-1 1977, IEC 584-2 1982)
Compensated range	—	-50 – +200 °C	-50 – +450 °C
Analog outputs			
Integrated outputs	2	—	—
Analog output range	voltage	0 – 10 V DC (5 kΩ – 1 MΩ)	—
	current	4 – 20 mA (max. 500 Ω)	—
Electrical specifications			
Number of channels	2	2	2
Power Supply	24 V DC (-15 – +10 %), 70 mA	24 V DC (-15 – +20 %), 1 W	24 V DC (-15 – +20 %), 1 W
Mechanical specifications			
Weight	kg	0.05	0.07
Dimensions (W x H x D)	mm	53.1 x 90 x 24.5	35.5 x 90 x 32.5
Order information			
Art. no.	151235	151238	151239

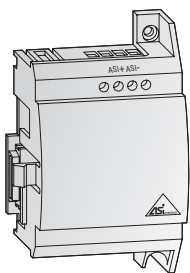

AS Interface Module AL2-ASI-BD

The Actuator Sensor Interface module AL2-ASI-BD in combination with an ALPHA 2 controller facilitates the data communications via an AS interface system. The AL2-ASI-BD is attached to an ALPHA 2 series module and forms a slave unit. Up to 4 inputs and 4 outputs can be exchanged with the ASI master.

The addresses of the slave devices in the ASI interface are assigned either automatically via the master in the network or via a programming device (software).

The maximum communication distance is 100 m without a repeater. If 2 repeaters are used, the distance is extended to up to 300 m.

For the AS interface a separate power supply is required. The communication signal is superimposed on the power supply of the AS interface bus.

Note: The AL2-ASI-BD cannot be used with the AL2-10MR series.

Specifications	AL2-ASI-BD	
Module type	Slave module	
Number of I/O points	4 inputs, 4 outputs	
External power supply	30.5 V DC (AS interface power supply)	
External current consumption	mA	Max. 40
Communications protocol	ASI standard	
Weight	kg	0.05
Dimensions (W x H x D)	mm	53.1 x 90 x 24.5
Order information	Art. no.	142525

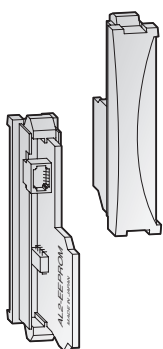

Memory Cassette AL2-EEPROM-2

With the AL2-EEPROM-2 memory cassettes, a new program can be transferred to the ALPHA 2 controller's internal system memory from the cassette, or the program of the internal system memory can be saved to the cassette.

If the memory cassette is used, a certain program can be run temporarily by simply plugging the external memory module onto the ALPHA 2.

After removing the memory cassette, the former program in the internal memory becomes active again.

The memory cassette AL2-EEPROM-2 is not a memory expansion device, but a medium for data exchange.

Specifications	AL2-EEPROM-2	
Memory type	EEPROM	
Application	ALPHA 2	
Memory capacity	5,000 bytes	
Function blocks	Max. 200	
Dimensions (W x H x D)	mm	10 x 45 x 25
Order information	Art. no.	142526

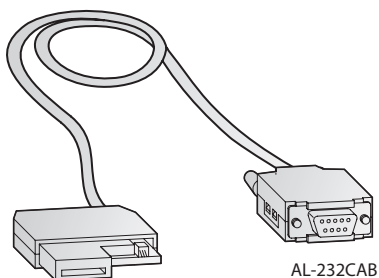

AL-232CAB

Interface Cable AL-232CAB

The AL-232CAB is an RS232C interface cable. It connects the ALPHA 2 controller to a personal computer running the programming software for the ALPHA 2 controller.

The cable ensures a galvanic isolation between the ALPHA 2 controller and the personal computer. The cable AL-232CAB can not be used for any other connection.

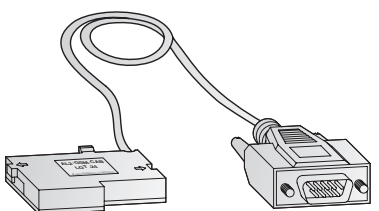

AL2-GSM-CAB

GSM Cable AL2-GSM-CAB

The GSM AL2-GSM-CAB is an RS232C interface cable and it is used to connect the ALPHA 2 controller to a normal or GSM modem, a personal computer or other serial devices. It can transfer SMS data to a GSM modem for onward transmission to mobile telephones or e-mail addresses. It also permits remote monitoring and remote maintenance.

Note: The above cables cannot be used with the AL2-10MR series.

Specifications	AL-232CAB	AL2-GSM-CAB
Connector	9-pin D-SUB female connector	9-pin D-SUB male connector
Application	ALPHA 2 <-> PC	ALPHA 2 <-> PC, modem
Length	m	2.5
Order information	Art. no.	87674
		142528

The MELSEC FX1S Series

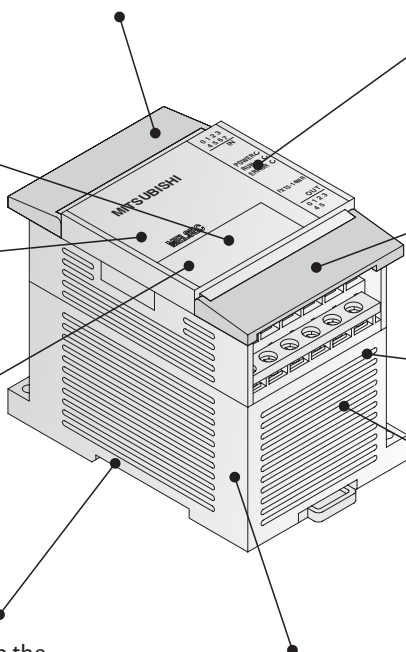

High-speed inputs for fast counting tasks with counting frequencies of up to 60 kHz and **interrupt processing capabilities**

All units feature two **analog potentiometers** for setpoint value entry and an **integrated RUN/STOP** switch.

The **internal service power supply unit** for 24 V DC has a capacity of 400 mA.
Note: service power supply is only available for AC Power Supply types.

Square pulse output (this applies only to transistor units.)
Two **integrated high speed pulse outputs** for frequencies up to 100 kHz for outputting **pulse signals** and controlling stepping motors

Integration of **interface, extension, and functions adapters** for direct installation in the base unit

Integrated real-time clock with year, month, day and time

Integrated serial RS422 interface for direct communication with computers

Your PLC programs are stored in a maintenance-free **EEPROM user memory** with a capacity of 2,000 program steps, so there is no need for a backup battery to protect against power failures.

Flexible installation with the integrated DIN rail adapter and screw fastening holes for mounting on flat surfaces

Password access protection facility for effective protection of your intellectual property.

Description of the Unit Components

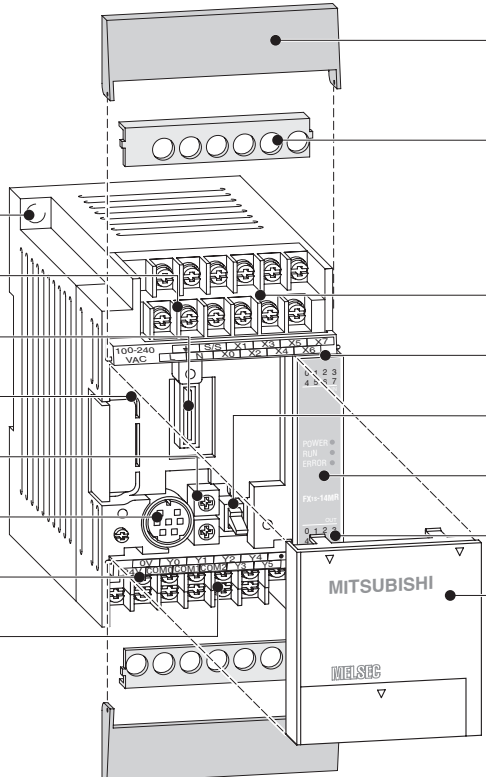

Protective cover

Terminal cover

Fixing hole

Connection of the power supply

Adapter interface

Slot for adapter

2 analog potentiometers

Connection for programming units

Service voltage source

Terminals for digital outputs

Terminals for digital inputs

LEDs for indicating the input status

RUN/STOP switch

LEDs for indicating the operating status

LEDs for indicating the output status

Housing cover

Base Units FX1S FX1N FX2N FX2NC FX3U

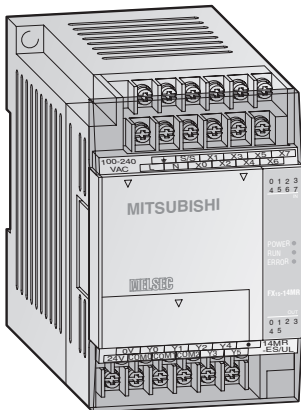

Base Units FX1S

The FX1S series base units are available with 10 to 30 input/output points.

It is possible to choose between relay and transistor output type.

Note: Versions with UL certification are available on request.

Special Features:

- Integrated power supply (AC or DC powered)
- Maintenance-free EEPROM memory
- Ample memory capacity (2000 steps) and device ranges
- High-speed operations
- Incorporated positioning control
- Integrated real-time clock
- System upgrades by exchangeable interface and I/O adapter boards for direct fitting into the base unit
- LEDs for indicating the input and output status
- Standard programming unit interface
- User-friendly programming systems, including IEC 61131.3 (EN 61131.3)-compatible programming software, HMIs and hand-held programming units

Base Units with 10 – 14 I/Os

Specifications	FX1S-10 MR-DS	FX1S-10 MR-ES/UL	FX1S-10 MT-DSS	FX1S-14 MR-DS	FX1S-14 MR-ES/UL	FX1S-14 MT-DSS
Max. number inputs/outputs	10	10	10	14	14	14
Power supply	24 V DC	100–240 V AC	24 V DC	24 V DC	100–240 V AC	24 V DC
Integrated inputs	6	6	6	8	8	8
Integrated outputs	4	4	4	6	6	6
Output type	Relay	Relay	Transistor (source)	Relay	Relay	Transistor (source)
Power consumption	W	6	19	6	6.5	19
Weight	kg	0.22	0.3	0.22	0.22	0.3
Dimensions (W x H x D)	mm	60 x 90 x 49	60 x 90 x 75	60 x 90 x 49	60 x 90 x 75	60 x 90 x 49
Order information	Art. no.	141240	141243	141246	141247	141248

Base Units with 20 – 30 I/Os

Specifications	FX1S-20 MR-DS	FX1S-20 MR-ES/UL	FX1S-20 MT-DSS	FX1S-30 MR-DS	FX1S-30 MR-ES/UL	FX1S-30 MT-DSS
Max. number inputs/outputs	20	20	20	30	30	30
Power supply	24 V DC	100–240 V AC	24 V DC	24 V DC	100–240 V AC	24 V DC
Integrated inputs	12	12	12	16	16	16
Integrated outputs	8	8	8	14	14	14
Output type	Relay	Relay	Transistor (source)	Relay	Relay	Transistor (source)
Power consumption	W	7	20	7	8	21
Weight	kg	0.3	0.4	0.3	0.35	0.45
Dimensions (W x H x D)	mm	75 x 90 x 49	75 x 90 x 75	75 x 90 x 49	100 x 90 x 49	100 x 90 x 75
Order information	Art. no.	141251	141252	141254	141255	141256

■ Base Units

FX1S FX1N FX2N FX2NC FX3U

Environmental Specifications

General specifications	Data
Ambient temperature	0 – 55 °C (storage temperature: -20 – +70 °C)
Protection	IP 10
Noise durability	1000 Vpp with noise generator; 1 µs at 30 – 100 Hz
Dielectric withstand voltage	1,500 V AC, 1 min. (500 V AC for direct voltage modules)
Ambient relative humidity	35 – 85 % (non-condensing)
Shock resistance	Acc. to IEC/EN 68-2-27: 15G (3 times each in 3 directions for 11 ms)
Vibration resistance	Acc. to IEC/EN 68-2-6: 1G (resistance to vibrations from 57 - 150 Hz for 80 minutes along all 3 axes); 0.5G for DIN rail mounting
Insulation resistance	500 V DC, 5 MΩ
Ground	Class D: Grounding resistance 100 Ω or less
Fuse rating	AC models: 250 V 1.0 A; DC models: 0.8 A
Environment	Avoid environments containing corrosive gases, install in a dust-free location.
Certifications	Please refer to page 86 in this catalogue

Electrical Specifications

Power supply specifications	DC powered modules (FX1S-□M□-DS/-DSS)	AC powered modules (FX1S-□M□-ES/UL)
Power supply	24 V DC (+10% / -15 %)	100 – 240 V AC (+10 % / -15 %), 50/60 Hz (±10 %)
Inrush current at ON	10 A / 0.1 ms (at 24 V DC)	15 A / 5 ms (at 100 V AC); 25 A / 5 ms (at 200 V AC)
Allowable momentary power failure time	5 ms	10 ms
Primary power supply	24 V DC, 400 mA	
External power supply (24 V DC)	—	400 mA

Output specifications	Relay modules	Transistor modules
Switching voltage (max.)	V < 250 V AC, < 30 V DC	5 – 30 V DC
Max. output current	- per output	0.5
	- per group*	0.8
Max. switching current	- inductive load	80 VA
	- lamp load	12 W
Response time	100	1.2
	ms 10	0.2
Life of contacts (switching times)**	3,000,000 at 20 VA; 1,000,000 at 35 VA; 200,000 at 80 VA	

* The limitation applies only per reference terminal for each group, 1 and 4 outputs for relays and transistors. Please observe the terminal assignments for the group identification.

** Not guaranteed by Mitsubishi Electric.

Programming Specifications

System specifications	FX1S
Program data	
Program memory	2,000 steps EEPROM (internal)
Program execution	Periodical execution of the stored program
Program protection	Password protection with 3 protection levels. Note: Protection levels may only be changed with FX-20P-E and FX-10P-E.
Number of instructions	27 sequence instructions, 2 step ladder instructions, 85 applied instructions
Cycle period	0.55 – 0.7 µs / logical instruction
Operands	
Internal relays	512 total, with 384 general (M0 – M383) and 128 latched (M384 – M511)
Special relays	256 (M8000 – M8255)
State relays	128
Timers	64 (max. 63 timers, partially switchable to 100 ms and 10 ms)
External setpoint entry via potentiometer	2 potentiometers
Counter	32 (16 bit), C0 – C31
High-speed counter inputs	1 phase, 6 points max: 60kHz / 2 points, 10kHz / 4 points; 2 phase, 2 points max: 30kHz / 1 point, 5kHz / 1 point
Data register	256 subtotal (128 general (D0 – D127) and 128 latched (D128 – D255))
Index register	16
Special register	256 (16 bit), D8000 – D8255
Pointer	64, P0 – P63
Nesting operands	8, N0 – N7
Interrupt inputs	6
Constants	16 bits: K: -32768 to +32767, hex: 0–FFFF 32 bits: K: -2147483648 to +2147483647, hex: 0–FFFF FFFF

The MELSEC FX1N Series

2
FX BASE UNITS

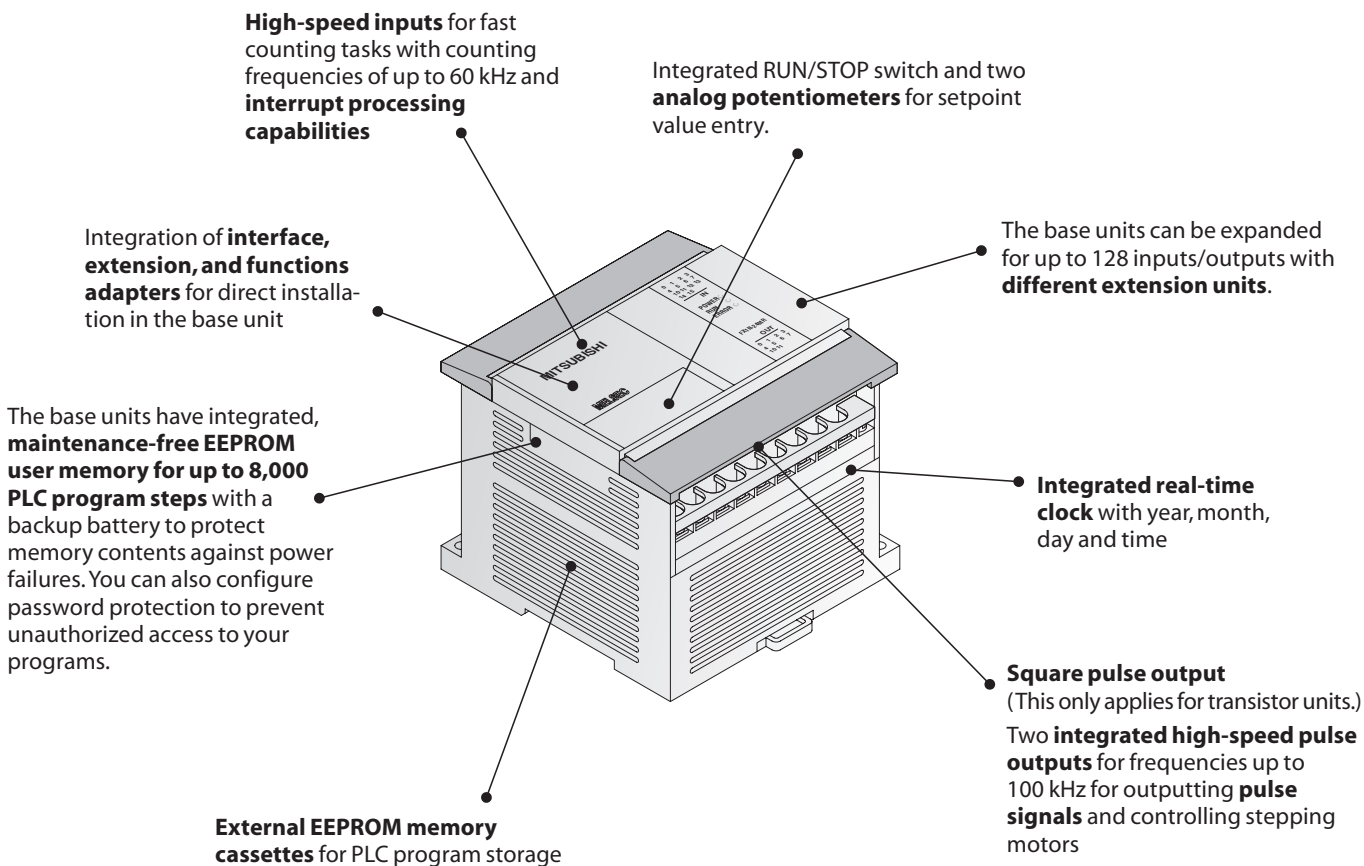

Description of the Unit Components

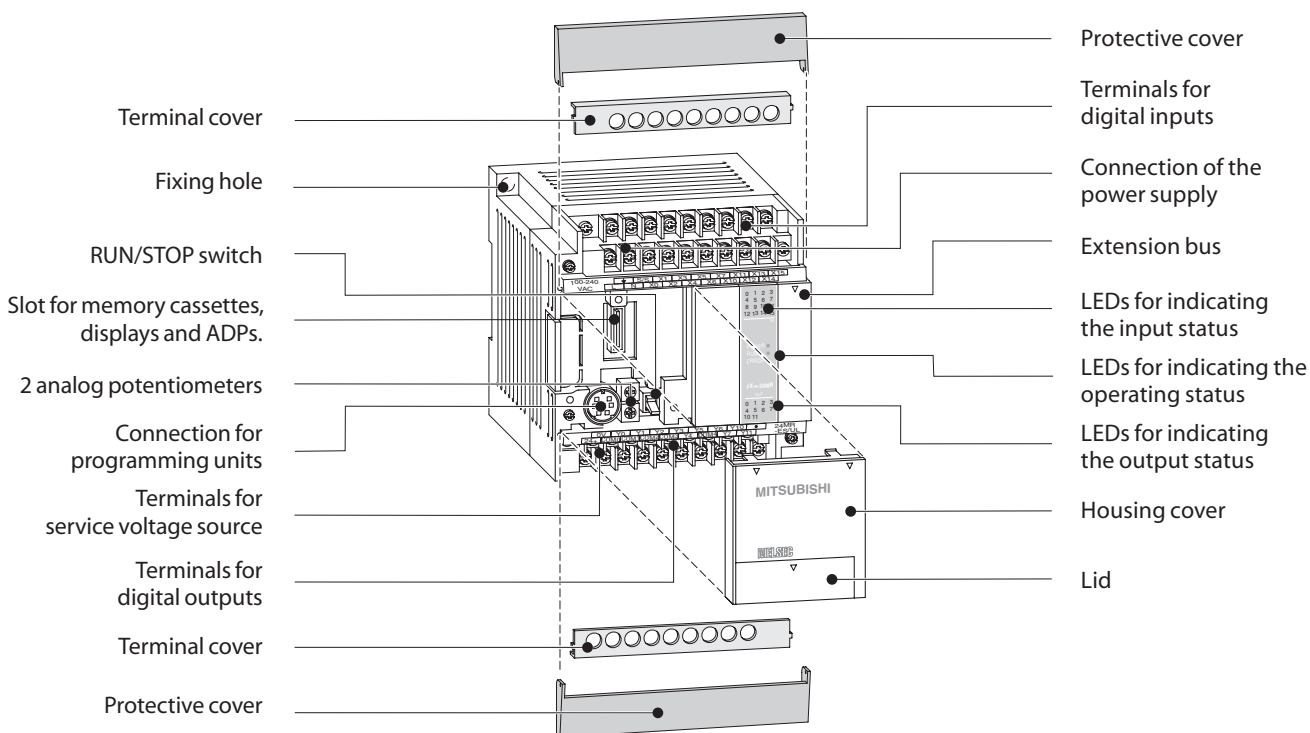

■ Base Units

FX1S FX1N FX2N FX2NC FX3U

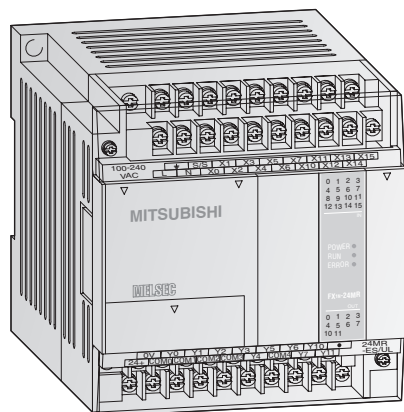

Base Units FX1N

The FX1N series base units are available with 14 to 60 input/output points.

It is possible to choose between relay and transistor output type.

Note: Versions with UL certification are available on request.

Special Features:

- Integrated serial interface for communication between Personal computers and HMI
- Standard programming unit interface
- LEDs for indicating the input and output status
- Detachable terminal blocks for units with 14, 24, 40, and 60 I/Os.
- Slot for memory cassettes
- All DC models with variable voltage from 12 up to 24 V
- Integrated real-time clock
- Exchangeable interface and I/O adapter boards for direct fitting into the base unit

Base Units with 14 – 24 I/Os

Specifications	FX1N-14 MR-DS	FX1N-14 MR-ES/UL	FX1N-14 MT-DSS	FX1N-24 MR-DS	FX1N-24 MR-ES/UL	FX1N-24 MT-DSS
Integrated inputs/outputs	14	14	14	24	24	24
Power supply	12–24 V	100–240 V	12–24 V	12–24 V	100–240 V	12–24 V
Integrated inputs	8	8	8	14	14	14
Integrated outputs	6	6	6	10	10	10
Output type	Relay	Relay	Transistor (source)	Relay	Relay	Transistor (source)
Power consumption	W 13	29	13	15	30	15
Weight	kg 0.45	0.45	0.45	0.45	0.45	0.45
Dimensions (W x H x D)	mm 90 x 90 x 75	90 x 90 x 75	90 x 90 x 75	90 x 90 x 75	90 x 90 x 75	90 x 90 x 75
Order information	Art. no. 141254	141259	141260	141261	141262	141263

Base Units with 40 – 60 I/Os

Specifications	FX1N-40 MR-DS	FX1N-40 MR-ES/UL	FX1N-40 MT-DSS	FX1N-60 MR-DS	FX1N-60 MR-ES/UL	FX1N-60 MT-DSS
Integrated inputs/outputs	40	40	40	60	60	60
Power supply	12–24 V DC	100–240 V AC	12–24 V DC	12–24 V DC	100–240 V AC	12–24 V DC
Integrated inputs	24	24	24	36	36	36
Integrated outputs	16	16	16	24	24	24
Output type	Relay	Relay	Transistor (source)	Relay	Relay	Transistor (source)
Power consumption	W 18	32	18	20	35	20
Weight	kg 0.65	0.65	0.65	0.8	0.8	0.8
Dimensions (W x H x D)	mm 130 x 90 x 75	130 x 90 x 75	130 x 90 x 75	175 x 90 x 75	175 x 90 x 75	175 x 90 x 75
Order information	Art. no. 141264	141265	141266	141267	141268	141269

Base Units FX1S **FX1N** FX2N FX2NC FX3U

Environmental Specifications

General specifications	Data
Ambient temperature	0 – 55 °C (storage temperature: -20 – +70 °C)
Protection	IP 10
Noise durability	1000 Vpp with noise generator; 1 µs at 30 – 100 Hz
Dielectric withstand voltage	1,500 V AC, 1 min. (500 V AC for direct voltage modules)
Ambient relative humidity	35 – 85 % (non-condensing)
Shock resistance	Acc. to IEC 68-2-27: 15G (3 times each in 3 directions for 11 ms)
Vibration resistance	Acc. to IEC 68-2-6: 1G (resistance to vibrations from 57 - 150 Hz for 80 minutes along all 3 axes); 0.5G for DIN rail mounting
Insulation resistance	500 V DC, 5 MΩ
Ground	Class D: Grounding resistance 100 Ω or less
Fuse rating	AC units: From FX1N-14M□ to FX1N-24M□: 250 V AC 1.0 A; From FX1N-40M□ to FX1N-60M□: 250 V AC 3.15 A / DC units: 125 V DC 3.15 A
Environment	Avoid environments containing corrosive gases, install in a dust-free location.
Certifications	Please refer to page 86 in this catalogue

Electrical Specifications

Power supply specifications	DC powered modules (FX1N-□M□-DS/-DSS)	AC powered modules (FX1N-□M□-ES/-UL)
Power supply	12–24 V DC (+20% / -15 %)	100 – 240 V AC (+10 % / -15 %), 50/60 Hz (±10 %)
Inrush current at ON	25 A / 1 ms (at 24 V DC); 22 A / 0.3 ms (at 12 V DC)	30 A / 5 ms (at 100 V AC); 50 A / 5 ms (at 200 V AC)
Allowable momentary power failure time	5 ms	10 ms
Primary power supply	24 V DC, 400 mA	
External power supply (24 V DC)	—	400 mA

Output specifications	Relay modules	Transistor modules
Switching voltage (max.)	V < 240 V AC, < 30 V DC	5 – 30 V DC
Max. output current	- per output	0.5
	- per group	0.8
Max. switching current - inductive load	80 VA	12 W
Response time	ms 10	< 0.2 (Y0, Y1 < 5 µs)
Life of contacts (switching times)*	3,000,000 at 20 VA; 1,000,000 at 35 VA; 200,000 at 80 VA	

* Not guaranteed by Mitsubishi Electric.

Programming Specifications

System specifications	FX1N
Program data	
I/O points (addresses)	128 (+4 optional)
Address range	Max. 128 inputs X0–X177, max. 128 outputs Y0–Y177
Program memory	8,000 steps EEPROM (internal), exchangeable EEPROM for easy program exchange
Cycle period	0.55 – 0.7 µs /logical instruction
Number of instructions	27 sequence instructions, 2 step ladder instructions, 89 applied instructions
Programming language	Step ladder, instruction list, SFC
Program execution	Cyclical execution, refresh mode processing
Program protection	Password protection with 3 protection levels*

* Protection levels may only be changed with FX-20P-E and FX-10P-E.

System specifications	FX1N
Operands	
Internal relays	1,536
Special relays	256
Step ladder	1,000
Timer	256
Ext. preset value via potentiometer	2
Counter	235
High-speed counter	1 phase, 6 points max: 60kHz / 2 points, 10kHz / 4 points; 2 phase, 2 points max: 30kHz / 1 point, 5kHz / 1 point
Real-time clock	Year, month, day, hour, minute, second, weekday
Data register	8,000
File register	Max. 7,000 (parameter editable), Total registers = 8,000
Index register	16
Special register	256
Pointer	128
Nestings	8
Interrupt inputs	6
Constants	16 bits: K: -32768 to +32767, hex: 0–FFFF; 32 bits: K: 2147483648 to +2147483647, hex: 0–FFFF FFFF

The MELSEC FX2N Series

Integrated high-speed counter inputs for processing fast input signals. For example, you can configure two 60 kHz counters and four 10 kHz counters.

Interrupt processing is also handled via the inputs.

Add-in function boards can be installed in the PLC to provide a **second RS485 / RS422 / RS232 communications interface** for programming or network configurations.

An add-in function board with 8 analog potentiometers is also available.

Integrated serial interface for direct communication with computers

An **integrated RUN/STOP** switch is available.

RAM/EEPROM memory for up to **16,000 PLC program steps** gives you plenty of reserve, even for big, complex applications.

The base units can be expanded to provide configurations with up to 256 inputs and outputs with **modular and compact extension units**.

Integrated real-time clock with year, month, day and time

Two **integrated pulse outputs** for frequencies from 2 to 20,000 Hz for controlling stepping motors and outputting **pulse-width modulated signals**.

Description of the Unit Components

Connection of the power supply

Terminal cover

Fixing hole

Extension connector for function boards

Back-up battery

Connection for programming units

RUN/STOP switch

Detachable terminal strip for digital outputs

Housing cover

Slot for memory cassettes

Detachable terminal strip for digital inputs

LEDs for indicating the input status

LEDs for indicating the operating status

Connection for extensions

Protective cover for the extension bus

LEDs for indicating the output status

Protective cover

■ Base Units
 FX1S FX1N FX2N FX2NC FX3U

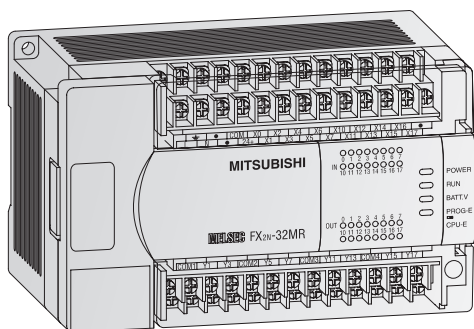

Base Units FX2N

The FX2N series base units are available with 16, 32, 48, 64, 80 or 128 input/output points.

It is possible to choose between relay and transistor output type. Triac output types for 110 V AC for sink/source are also available.

Note: Additional special versions are available on request.

Special Features:

- Exchangeable interface modules for direct mounting into a base unit
- Standard programming unit interface
- LEDs for indicating the input and output status
- Detachable terminal blocks (except for 16 I/O base units)
- Slot for memory cassettes for up to 16 k steps PLC program
- Integrated real-time clock

Base Units with 16 I/Os

Specifications	FX2N-16 MR-DS	FX2N-16 MR-ES/UL	FX2N-16 MT-DSS	FX2N-16 MT-ESS/UL
Integrated inputs/outputs	16	16	16	16
Power supply	24 V DC	100–240 V AC	24 V DC	100–240 V AC
Integrated inputs	8	8	8	8
Integrated outputs	8	8	8	8
Output type	Relay	Relay	Transistor (source type)	Transistor (source type)
Power consumption	20 W	30 VA	20 W	30 VA
Weight	kg 0.6	0.6	0.6	0.6
Dimensions (W x H x D)	mm 130 x 90 x 87	130 x 90 x 87	130 x 90 x 87	130 x 90 x 87
Order information	Art. no. 141270	141271	103689	141272

Base Units with 32 I/Os

Specifications	FX2N-32 MR-DS	FX2N-32 MR-ES/UL	FX2N-32 MT-DSS	FX2N-32 MT-ESS/UL
Integrated inputs/outputs	32	32	32	32
Power supply	24 V DC	100–240 V AC	24 V DC	100–240 V AC
Integrated inputs	16	16	16	16
Integrated outputs	16	16	16	16
Output type	Relay	Relay	Transistor (source type)	Transistor (source type)
Power consumption	25 W	40 VA	25 W	40 VA
Weight	kg 0.65	0.65	0.65	0.65
Dimensions (W x H x D)	mm 150 x 90 x 87	150 x 90 x 87	150 x 90 x 87	150 x 90 x 87
Order information	Art. no. 141273	141274	141275	141276

Base Units with 48 I/Os

Specifications	FX2N-48 MR-DS	FX2N-48 MR-ES/UL	FX2N-48 MT-ESS/UL	FX2N-48 MT-DSS
Integrated inputs/outputs	48	48	48	48
Power supply	24 V DC	100–240 V AC	100–240 V AC	24 V DC
Integrated inputs	24	24	24	24
Integrated outputs	24	24	24	24
Output type	Relay	Relay	Transistor (source type)	Transistor (source type)
Power consumption	30 W	50 VA	50 VA	30 W
Weight	kg 0.85	0.85	0.85	0.85
Dimensions (W x H x D)	mm 182 x 90 x 87	182 x 90 x 87	182 x 90 x 87	182 x 90 x 87
Order information	Art. no. 141277	141278	141280	141279

Base Units with 64 I/Os

Specifications	FX2N-64 MR-DS	FX2N-64 MR-ES/UL	FX2N-64 MT-ESS/UL	FX2N-64 MT-DSS
Integrated inputs/outputs	64	64	64	64
Power supply	24 V DC	100–240 V AC	100–240 V AC	24 V DC
Integrated inputs	32	32	32	32
Integrated outputs	32	32	32	32
Output type	Relay	Relay	Transistor (source type)	Transistor (source type)
Power consumption	35 W	60 VA	60 VA	35 W
Weight	kg 1.0	1.0	1.0	1.0
Dimensions (W x H x D)	mm 220 x 90 x 87	220 x 90 x 87	220 x 90 x 87	220 x 90 x 87
Order information	Art. no. 141281	141282	141284	141283

Base Units with 80 – 128 I/Os

Specifications	FX2N-80 MR-DS	FX2N-80 MR-ES/UL	FX2N-80 MT-DSS	FX2N-80 MT-ESS/UL	FX2N-128 MR-ES/UL	FX2N-128 MT-ESS/UL
Integrated inputs/outputs	80	80	80	80	128	128
Power supply	24 V DC	100–240 V AC	24 V DC	100–240 V AC	100–240 V AC	100–240 V AC
Integrated inputs	40	40	40	40	64	64
Integrated outputs	40	40	40	40	64	64
Output type	Relay	Relay	Transistor (source type)	Transistor (source type)	Relay	Transistor (source type)
Power consumption	40 W	70 VA	40 W	70 VA	100 VA	100 VA
Weight	kg 1.2	1.2	1.2	1.2	1.8	1.8
Dimensions (W x H x D)	mm 285 x 90 x 87	285 x 90 x 87	285 x 90 x 87	285 x 90 x 87	350 x 90 x 87	350 x 90 x 87
Order information	Art. no. 141286	141287	141288	141289	141290	141292

Base Units FX1S FX1N FX2N FX2NC FX3U

Environmental Specifications

General specifications	Data
Ambient temperature	0 – 55 °C (storage temperature: -20 – +70 °C)
Protection	IP 10
Noise durability	1000 Vpp with noise generator; 1 µs at 30 – 100 Hz
Dielectric withstand voltage	DC PSU: 500 V AC, 1 min AC PSU: 1,500 V AC, 1 min
Ambient relative humidity	35 – 85 % (non-condensing)
Shock resistance	Acc. to IEC 68-2-27: 15G (3 times each in 3 directions for 11 ms)
Vibration resistance	Acc. to IEC 68-2-6: 1G (resistance to vibrations from 57 – 150 Hz for 80 minutes along all 3 axes); 0.5G for DIN rail mounting
Insulation resistance	500 V DC, 5 MΩ
Ground	Class D: Grounding resistance 100 Ω or less
Fuse	From FX2N-16M□ to FX2N-32M□: 3.15 A; From FX2N-48M□ to FX2N-128M□: 5 A
Environment	Avoid environments containing corrosive gases, install in a dust-free location.
Certifications	Please refer to page 86 in this catalogue

Electrical Specifications

Power supply specifications	DC powered modules (FX2N-□M□-DS/-DSS)	AC powered modules (FX2N-□M□-ES/UL)
Power supply	24 V DC (+20% / -30 %)	100 – 240 V AC (+10 % / -15 %), 50/60 Hz
Inrush current at ON	—	40 A / <5 ms (at 100 V AC); 60 A / <5 ms (at 200 V AC)
Allowable momentary power failure time	5 ms	10 ms
Primary power supply	24 V DC	—
External power supply (24 V DC)	—	FX2N-16/32M: 250 mA / FX2N-48/64/80/128M: 460 mA

Output specifications	Relay modules	Transistor modules
Switching voltage (max.)	V < 240 V AC, < 30 V DC	5 – 30 V DC
Max. output current	- per output: A 2 - per group*: A 8	0.5 / 0.3 ^① 0.8 / 1.6 ^②
Max. switching current	- inductive load: 80 VA	12 W / 7.2 W
Response time	ms 10	<0.2(Y0,Y1<30 µs)
Life of contacts (switching times) ^③	3,000,000 at 20 VA; 1,000,000 at 35 VA; 200,000 at 80 VA	

① for Y0 and Y1 = 0.3 A; all others 0.5 A ② 0.8 for 4 per group and 1.6 for 8 per group
 ③ Not guaranteed by Mitsubishi Electric.
 * This limitation applies only per reference terminal for each group, 4 and 8 outputs for relays and 2 and 4 outputs for transistors. Please observe the terminal assignments for the group identification.

Programming Specifications

System specifications	FX2N
Program data	
I/O points (addresses)	256
Address range	Max. 189 inputs X0-X267, max. 184 outputs Y0-Y267
Program memory	8,000 steps RAM (internal), 4,000 and 8,000 steps EEPROM cassettes (optional), 16,000 steps RAM cassettes (optional), 16,000 steps EPROM cassette (optional), 16,000 steps EEPROM cassettes (optional)
Cycle period	0.08 µs / logical instruction
Number of instructions	27 sequence instructions, 2 step ladder instructions, 132 applied instructions
Programming language	Step ladder, instruction list, SFC
Program execution	Cyclical execution, refresh mode processing
Program protection	Password protection with 3 protection levels*

* Protection levels may only be changed with FX-20P-E and FX-10P-E.

System specifications	FX2N
Operands	
Internal relays	3,072
Special relays	256
Step ladder	1,000
Timer	256
Ext. preset value via potentiometer	—
Counter	235
High-speed counter	6 single phase inputs (max. 60 kHz), 2 double phase inputs (max. 30 kHz)
Real-time clock	Year, month, day, hour, minute, second, weekday
Data register	8,000
File register	Max. 7,000 (parameter editable), Total registers = 8,000
Index register	16
Special register	256
Pointer	128
Nestings	8
Interrupt inputs	6
Constants	16 bits: K: -32768 to +32767, hex: 0–FFFF 32 bits: K: 2147483648 to +2147483647, hex: 0–FFFF FFFF 32 bits floating point: 0, ±1.175 x 10 ⁻³⁸ to ±3.403 x 10 ⁻³⁸

The MELSEC FX2NC Series

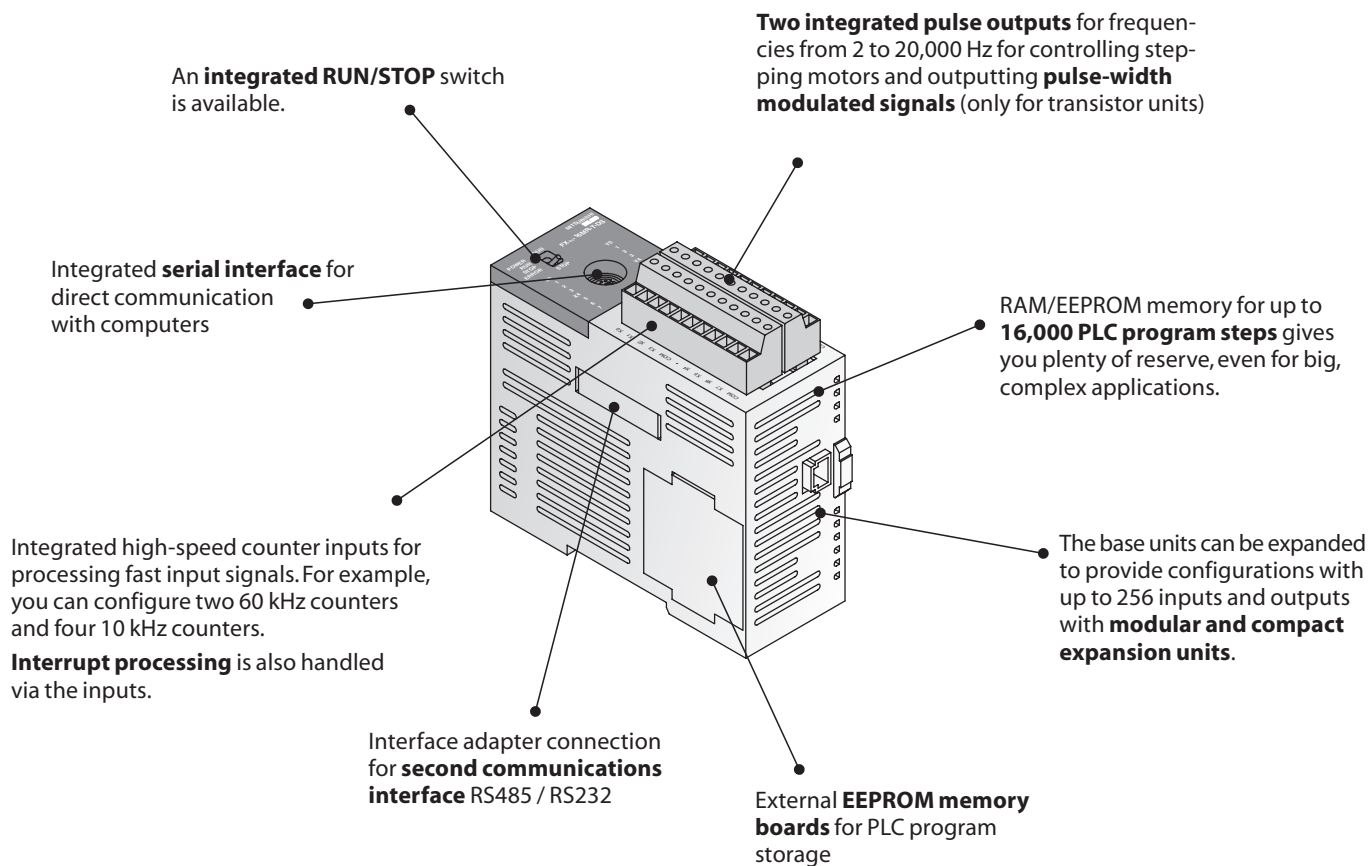

Description of the Unit Components

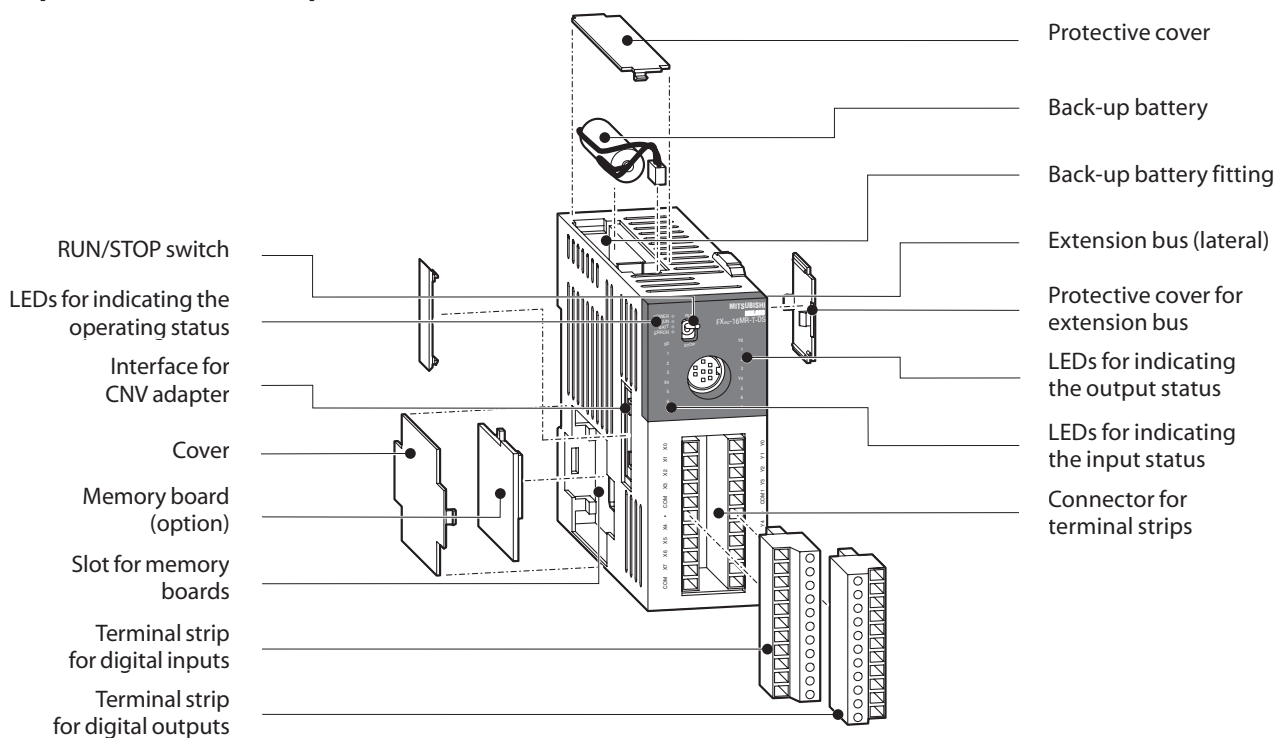

■ Base Units

FX1S FX1N FX2N FX2NC FX3U

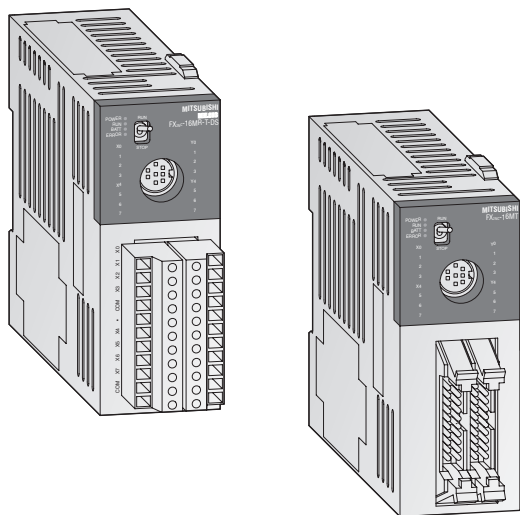

Base Units FX2NC

The base units of the FX2NC are available in versions with 16, 32, 64 or 96 I/Os. Nine output types are available: eight different transistor output types and one relay output type.

Note: Versions with UL certification are available on request.

Special Features:

- Very compact dimensions
- Standard programming unit interface
- LEDs for indicating the input and output status
- Removable terminal blocks (screw terminals for the relay output type) or ribbon cable connectors (for the transistor output types) for system cabling
- Slot for memory boards for up to 16 k steps PLC program
- Adapter modules and system cabling sets available for units with ribbon cable connectors (see accessories)

Base Units with 16 – 96 I/Os

Specifications	FX2NC-16 MT-DSS	FX2NC-16 MR-T-DS	FX2NC-32 MT-DSS	FX2NC-64 MT-DSS	FX2NC-96 MT-DSS
Integrated inputs/outputs	16	16	32	64	96
Integrated inputs	8	8	16	32	48
Integrated outputs	8	8	16	32	48
Output type	Transistor (source)	Relay	Transistor (source)	Transistor (source)	Transistor (source)
Power consumption	W 6	6	8	11	14
Weight	kg 0.2	0.25	0.2	0.35	0.45
Dimensions (W x H x D)	mm 35 x 90 x 87	35 x 90 x 89	35 x 90 x 87	60 x 90 x 87	86 x 90 x 87
Order information	Art. no. 104499	128141	104500	104501	104502

■ Base Units

FX1S FX1N FX2N FX2NC FX3U

Environmental Specifications

General specifications	Data
Ambient temperature	0 – 55 °C (storage temperature: -20 – +70 °C)
Protection	IP 10
Noise durability	1000 Vpp with noise generator; 1 µs at 30 – 100 Hz
Dielectric withstand voltage	DC PSU: 500 V AC, 1 min AC PSU: 1,500 V AC, 1 min
Ambient relative humidity	35 – 85 % (non-condensing)
Shock resistance	Acc. to IEC 68-2-27: 15G (3 times each in 3 directions for 11 ms)
Vibration resistance	Acc. to IEC 68-2-6: 1G (resistance to vibrations from 57 – 150 Hz for 80 minutes along all 3 axes); 0.5G for DIN rail mounting
Insulation resistance	500 V DC, 5 MΩ
Ground	Class D: Grounding resistance 100 Ω or less
Fuse	FX2NC-16MR-T-DS: 2.5 A; FX2NC-□□MT-DSS: 3.15 A
Environment	Avoid environments containing corrosive gases, install in a dust-free location.
Certifications	Please refer to page 86 in this catalogue

Electrical Specifications

Power supply specifications	DC powered modules
Power supply	24 V DC (+20% / -15 %)
Inrush current at ON	30 A, 0.5 ms / 24 V DC
Allowable momentary power failure time	5 ms

Output specifications	Relay modules	Transistor modules
Switching voltage (max.)	V < 250 V AC, < 30 V DC	5 – 30 V DC
Max. output current	- per output A	0.1 / 0.3 ^①
	- per group A	0.8
Max. switching current	- inductive load	2.4 W / 7.2 W ^②
		< 0.2 OFF → ON Y000, Y001–15 ON → OFF Y000, Y001–30
Response time	ms 10	
Life of contacts (switching times) ^③	3,000,000 at 20 VA; 1,000,000 at 35 VA; 200,000 at 80 VA	

^① for Y0 to Y3 = 0.3 A; all others 0.1 A
^③ Not guaranteed by Mitsubishi Electric.

^② 7.2 W for Y0 to Y3; all others 2.4 W

Programming Specifications

System specifications	FX2NC
Program data	
I/O points (addresses)	256
Address range	Max. 189 inputs X0-X267, max. 184 outputs Y0-Y267
Program memory	8,000 steps RAM (internal), 16,000 steps EEPROM cassettes (optional), 4,000 steps EPROM cassettes with RTC (optional) 16,000 steps EEPROM cassettes with RTC (optional)
Cycle period	0.08 µs / logical instruction
Number of instructions	27 sequence instructions, 2 step ladder instructions, 132 applied instructions
Programming language	Step ladder, instruction list, SFC
Program execution	Cyclical execution, refresh mode processing
Program protection	Password protection with 3 protection levels*

* Protection levels may only be changed with FX-20P-E and FX-10P-E.

System specifications	FX2NC
Operands	
Internal relays	3,072
Special relays	256
Step ladder	1,000
Timer	256
Ext. preset value via potentiometer	—
Counter	235
High-speed counter	6 single phase inputs (max. 60 kHz), 2 double phase inputs (max. 30 kHz)
Real-time clock	Year, month, day, hour, minute, second, weekday
Data register	8,000
File register	Max. 7,000 (parameter editable), Total registers = 8,000
Index register	16
Special register	256
Pointer	128
Nestings	8
Interrupt inputs	6
Constants	16 bits: K: -32768 to +32767, hex: 0–FFFF 32 bits: K: 2147483648 to +2147483647, hex: 0–FFFF FFFF 32 bits floating point: 0, ±1.175 x 10 ⁻³⁸ to ±3.403 x 10 ³⁸

The MELSEC FX3U Series

2
FX BASE UNITS

RAM/EEPROM memory for up to **64,000 PLC program steps** gives you plenty of reserve, even for big, complex applications.

Integrated high-speed counter inputs for processing fast input signals. For example, you can configure six 100 kHz counters and two 10 kHz counters.

Interrupt processing is also handled via the inputs.

Add-in function boards can be installed in the PLC to provide a **second RS485 / RS422 / RS232/USB communications interface** for programming or network configurations.

The base units can be expanded to provide configurations with up to 384 inputs and outputs with **compact extension units** (total of 384 only by using main unit I/Os, extension unit I/Os and remote I/Os).

Integrated real-time clock with year, month, days and time

An **integrated RUN/STOP** switch is available.

Integrated serial interface for direct communication with computers

Three **integrated pulse outputs** for frequencies up to 100 kHz **with deceleration and acceleration ramps** for controlling stepping motors and outputting **pulse-width modulated signals**.

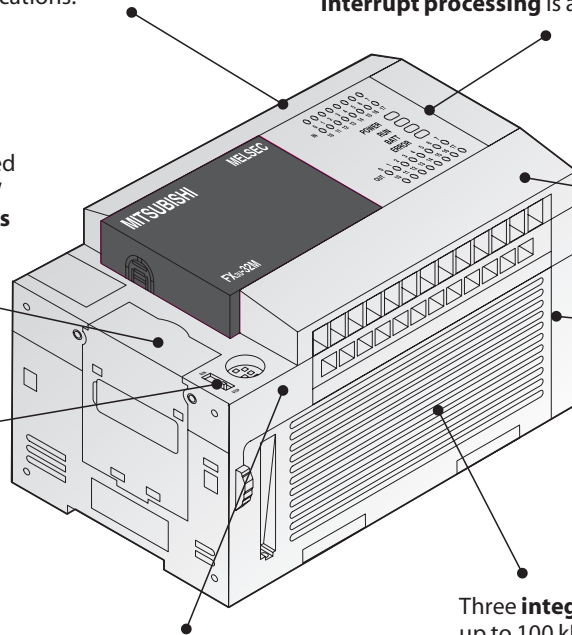

Description of the Unit Components

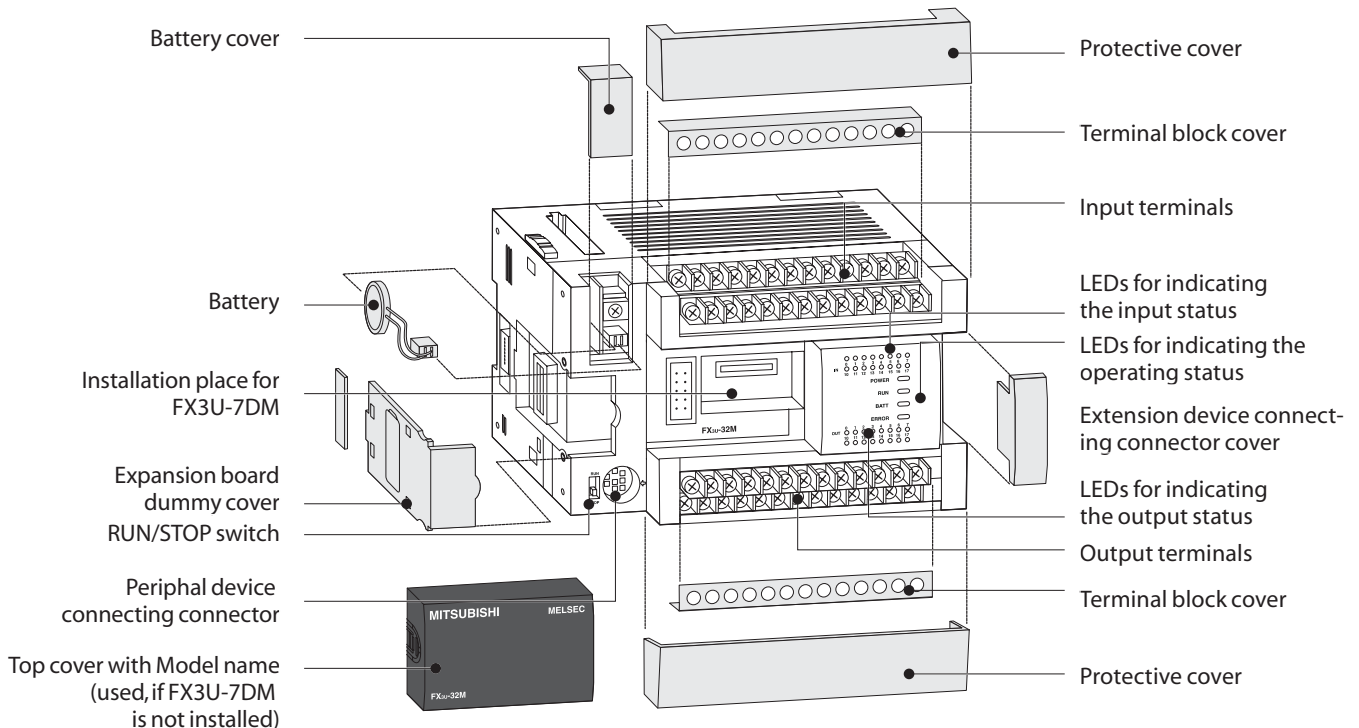

■ Base Units

FX1S FX1N FX2N FX2NC FX3U

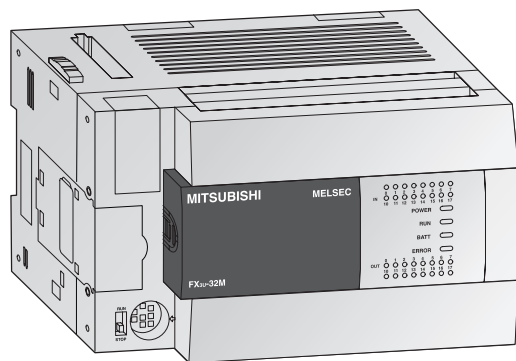

Base Units FX3U

The FX3U series base units are available with 16, 32, 48, 64 or 80 input/output points.

All base units provide the relay output type.

Special Features:

- Exchangeable interface modules for direct mounting into a base unit
- Standard programming unit interface
- LEDs for indicating the input and output status
- Slot for memory cassettes for up to 64 k steps PLC program
- Integrated real-time clock

2
FX BASE UNITS

Base Units with 16 – 80 I/Os

Specifications	FX3U-16 MR/ES	FX3U-32 MR/ES	FX3U-48 MR/ES	FX3U-64 MR/ES	FX3U-80 MR/ES
Integrated inputs/outputs	16	32	48	64	80
Power supply	100–240 V AC	100–240 V AC	100–240 V AC	100–240 V AC	100–240 V AC
Integrated inputs	8	16	24	32	40
Integrated outputs	8	16	24	32	40
Output type	Relay	Relay	Relay	Relay	Relay
Power consumption	W 30	35	40	45	50
Weight	kg 0.60	0.65	0.85	1.00	1.20
Dimensions (W x H x D)	mm 130 x 90 x 86	150 x 90 x 86	182 x 90 x 86	220 x 90 x 86	285 x 90 x 86
Order information	Art. no. 165236	165237	165238	165239	165240

■ **Base Units** □ FX1S □ FX1N □ FX2N □ FX2NC **FX3U**

Environmental Specifications

General specifications	Data
Ambient temperature	0 – 55 °C (storage temperature: -25 – +75 °C)
Protection	IP 10
Noise durability	1000 Vpp with noise generator; 1 μs at 30 – 100 Hz
Dielectric withstand voltage	AC PSU: 1500 V AC, 1 min. / DC PSU: 500 V AC, 1 min.
Ambient relative humidity	5 – 95 % (non-condensing)
Shock resistance	Acc. to IEC 68-2-27: 15G (3 times each in 3 directions for 11 ms)
Vibration resistance	Acc. to IEC 68-2-6: 1G (resistance to vibrations from 57 - 150 Hz for 80 minutes along all 3 axes); 0.5G for DIN rail mounting
Insulation resistance	500 V DC, 5 MΩ
Ground	Class D: Grounding resistance 100 Ω or less
Fuse	From FX3U-16M□ to FX3U-32M□: 3.15 A; From FX3U-48M□ to FX3U-80M□: 5 A
Environment	Avoid environments containing corrosive gases, install in a dust-free location.
Certifications	Please refer to page 86 in this catalogue

Electrical Specifications

Power supply specifications	AC powered modules (FX3U-□MR/ES)
Power supply	100 – 240 V AC (+10 % / -15 %), 50/60 Hz
Inrush current at ON	30 A / <5 ms (at 100 V AC); 65 A / <5 ms (at 200 V AC)
Allowable momentary power failure time	10 ms
Primary power supply	—
External power supply (24 V DC)	FX3U-16/32MR/ES: 400 mA / FX3U-48/64/80MR/ES: 600 mA

Output specifications	Relay modules
Switching voltage (max.)	V < 240 V AC, < 30 V DC
Max. output current	- per output A 2
	- per group A 8
Max. switching current - inductive load	VA 80
Response time	ms 10
Life of contacts (switching times) ^③	3,000,000 at 20 VA; 1,000,000 at 35 VA; 200,000 at 80 VA

③ Not guaranteed by Mitsubishi Electric.

Programming Specifications

System specifications	FX3U
Program data	
I/O points (addresses)	Max. total 384 (with remote I/O)
Address range	Max. 256 direct addressing and max. 256 network I/Os
Program memory	64,000 steps RAM (internal), exchangeable FLROM for easy program exchange
Cycle period	0.065 μs /basic instruction
Number of instructions	27 sequence instructions, 2 step ladder instructions, 209 applied instructions
Programming language	Step ladder, instruction list, SFC
Program execution	Cyclical execution, refresh mode processing
Program protection	Password protection with 3 protection levels*

* Protection levels may only be changed with FX-20P-E and FX-10P-E.

System specifications	FX3U
Operands	
Internal relays	7,680
Special relays	512
State relays	4,096
Timer	512
Counter	235
High-speed counter	16
High-speed counter speed	1 phase, 8 points max: 100kHz / 6 points 10kHz / 2 points 2 phase, 2 points max: 50kHz / 2 points
Real-time clock	Year, month, day, hour, minute, second, weekday
Data register	8,000
Extension file register	32768
Index register	16
Special register	512
Pointer	4,096
Nestings	8
Interrupt inputs	6
Constants	16 bits: K: -32768 to +32768, hex: 0-FFFF; 32 bits: K: -2147483648 to +2147483647; hex: 0-FFFF FFFF

Powered Compact Extension Units

FX1S FX1N FX2N FX2NC FX3U

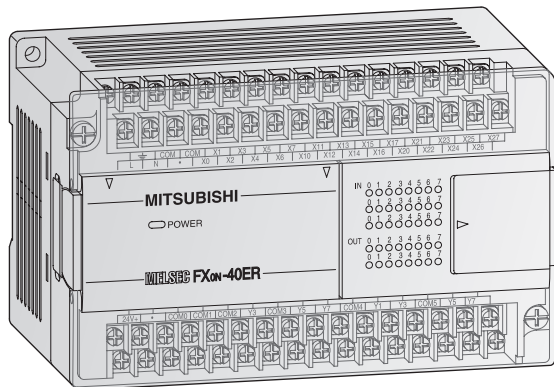

Extension Units FX0N

The FX0N series extension units are available with 40 input/output points.

It is possible to choose between relay and transistor output type.

Special Features:

- LEDs for indicating the input and output status
- MELSEC FX1N series compatible
- Integrated service power supply with up to 200 mA capacity

3

EXTENSION MODULES

Specifications	FX0N-40 ER-ES/UL	FX0N-40 ER-DS	FX0N-40 ET-DSS
Electrical data			
Integrated inputs/outputs	40	40	40
Power supply	AC range (+10%, -15%)	100 – 240 V	—
	Frequency at AC	Hz 50/60	—
	DC range (+20%, -15%)	—	24 V
Max. input apparent power	40 VA	20 W	30 W
Inrush current at ON	100 V AC	30 A / 5 ms	—
	200 V AC	50 A / 5 ms	—
	24 V DC	—	60 A / 50 μs
Allowable momentary power failure time	ms	10	5
External service power supply (24 V DC)	mA	200	—
Inputs			
Integrated inputs	24	24	24
Min. current for logical 1	mA	3.5	3.5
Max. current for logical 0	mA	1.5	1.5
Response time	For all base units of the MELSEC FX0N series: 10 ms (at time of shipment)		
Outputs			
Integrated outputs	16	16	16
Output type	Relay	Relay	Transistor
Max. switching voltage	Generally for relay version: < 240 V AC, < 30 V DC; for transistor version: 5 – 30 V DC		
Max. output current	- per output	A	2
	- per group*	A	5
Max. switching power	- inductive load	VA	80
			12
Response time	ms	10	< 0.2
Life of contacts (switching times) ^②	For all extension units of the MELSEC FX0N series: 3,000,000 at 20 VA; 1,000,000 at 35 VA; 200,000 at 80 VA (only for relay output)		
Mechanical data			
Weight	kg	0.75	0.75
Dimensions (W x H x D)	mm	150 x 90 x 87	150 x 90 x 87
Order information	Art. no.	60012	55955
			55954

① 0.8 for 4 per group

② Not guaranteed by Mitsubishi Electric.

* This limitation applies only per reference terminal for each group. Please observe the terminal assignments for the group identification.

Powered Compact Extension Units

FX1S FX1N FX2N FX2NC FX3U

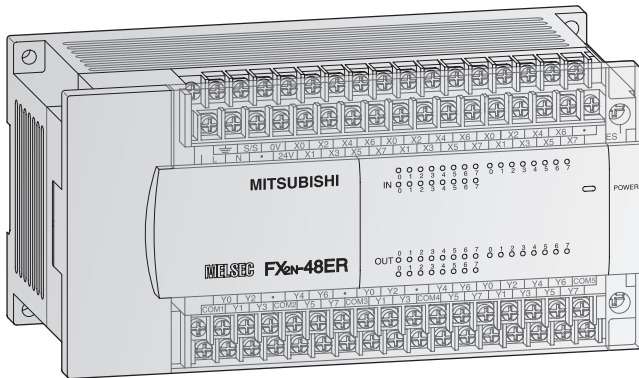

Extension Units FX2N

The FX2N series extension units are available with 32 or 48 input/output points.

It is possible to choose between relay and transistor output type.

Special Features:

- LEDs for indicating the input and output status
- MELSEC FX1N/FX2N and FX3U series compatible
- Detachable terminal blocks
- Integrated service power supply with 250 mA or 460 mA

Specifications	FX2N-32 ER-ES/UL	FX2N-32 ET-ESS/UL	FX2N-48 ER-DS	FX2N-48 ER-ES/UL	FX2N-48 ET-DSS	FX2N-48 ET-ESS/UL
Electrical data						
Integrated inputs/outputs	32	32	48	48	48	48
Power supply	AC range (+10 %, -15 %)	100 – 240 V	100 – 240 V	100 – 240 V	—	100 – 240 V
	frequency at AC	50/60 Hz	50/60	—	50/60	—
	DC range (+20 %, -30 %)	—	—	24 V	—	24 V
Max. input apparent power	35 VA	35 VA	30 W	45 VA	30 W	45 VA
Inrush current at ON	100 V AC	40 A < 5 ms	40 A < 5 ms	—	40 A < 5 ms	40 A < 5 ms
	200 V AC	60 A < 5 ms	—	—	60 A < 5 ms	60 A < 5 ms
Allowable momentary power failure time	ms	10	5	10	5	10
External service power supply (24 V DC)	mA	250	—	460	—	460
Power supply int. bus (5 V DC)	mA	690	690	690	690	690
Inputs						
Integrated inputs	16	16	24	24	24	24
Min. current for logical 1	mA	3.5	3.5	3.5	3.5	3.5
Max. current for logical 0	mA	1.5	1.5	1.5	1.5	1.5
Response time	For all extension units of the MELSEC FX2N series: 10 ms (at time of shipment)					
Outputs						
Integrated outputs	16	16	24	24	24	24
Output type	Relay	Transistor (source)	Relay	Relay	Transistor (source)	Transistor (source)
Switching voltage (max.)	Generally for relay version: < 264 V AC, < 30 V DC; for transistor version: 5 – 30 V DC					
Max. output current	- per output	A	2	0.5	2	0.5
	- per group *	A	8	0.8 / 1.6 ^②	8	0.8 / 1.6 ^②
Max. switching power - inductive load	W	80	12	80	12	12
Response time	ms	10	< 0.2	10	< 0.2	< 0.2
Life of contacts (switching times) ^①	For all extension units of the MELSEC FX2N series: 3,000,000 at 20 VA; 1,000,000 at 35 VA; 200,000 at 80 VA (for relay output only)					
Mechanical data						
Weight	kg	0.65	0.65	0.85	0.85	0.85
Dimensions (W x H x D)	mm	150 x 90 x 87	150 x 90 x 87	182 x 90 x 87	182 x 90 x 87	182 x 90 x 87
Order information	Art. no.	65568	65569	66633	65571	66634

① Not guaranteed by Mitsubishi Electric ② 0.8 for 4 per group and 1.6 for 8 per group

* This limitation applies only per reference terminal for each group. Please observe the terminal assignments for the group identification.

■ Unpowered Modular Extension Blocks

□ FX1S ✓ FX1N ✓ FX2N ✓ FX2NC ✓ FX3U

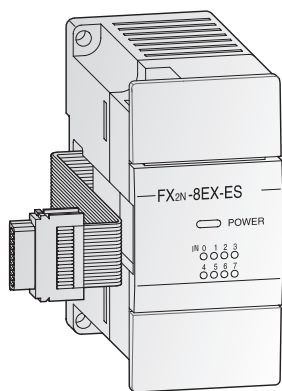

FX2N-8EX-ES

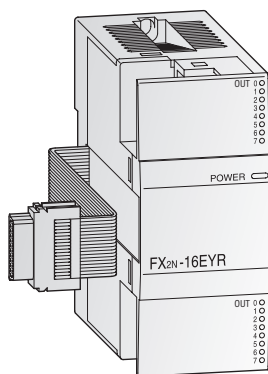

FX2N-16EYR-ES/UL

Extension Blocks FX2N

The FX2N series modular extension blocks are available with 8 or 16 input/output points.

It is possible to choose between relay and transistor output type.

Note: When attaching an extension block to a FX2NC base unit, the interface adapter FX2N-CNV-IF is required.

Special Features:

- LEDs for indicating the input and output status
- MELSEC FX1N/FX2N/FX2NC and FX3U series compatible
- Very compact dimensions
- Vertically terminal blocks with a cable guide to the upper or lower side

Specifications	FX2N-8 ER-ES/UL	FX2N-8 EX-ES/UL	FX2N-8 EYR-ES/UL	FX2N-8 EYT-ESS/UL	FX2N-16 EX-ES/UL	FX2N-16 EYR-ES/UL	FX2N-16 EYT-ESS/UL
Electrical data							
Integrated inputs/outputs	8	8	8	8	16	16	16
Power supply	All modular extension blocks are supplied by the base unit.						
Inputs							
Integrated inputs	4	8	—	—	16	—	—
Min. current for logical 1	mA	3.5	3.5	—	3.5	—	—
Max. current for logical 0	mA	1.5	1.5	—	1.5	—	—
Response time	For all extension blocks of the MELSEC FX2N series: 10 ms (at time of shipment)						
Outputs							
Integrated outputs	4	—	8	8	—	16	16
Output type	Relay	—	Relay	Transistor	—	Relay	Transistor (source)
Max. switching voltage	Generally for relay version: < 240 V AC, < 30 V DC; for transistor version: 5 – 30 V DC						
Max. output current	- per output	A	2	—	2	0.5	—
	- per group ^①	A	8	—	8	0.8	—
Max. switching power	- inductive load	VA	80	—	80	12	—
Response time	ms	10	10	10	< 0.2	—	10
Life of contacts (switching times) ^②	For all extension units of the MELSEC FX2N series: 3,000,000 at 20 VA; 1,000,000 at 35 VA; 200,000 at 80 VA (for relay output only)						
Mechanical data							
Weight	kg	0.2	0.2	0.2	0.2	0.3	0.3
Dimensions (W x H x D)	mm	43 x 90 x 87	43 x 90 x 87	43 x 90 x 87	43 x 90 x 87	40 x 90 x 87	40 x 90 x 87
Order information	Art. no.	60023	60013	60014	60016	65776	65580
						65581	

① This limitation applies only per reference terminal for each group. Please observe the terminal assignments for the group identification.

② Not guaranteed by Mitsubishi Electric

Unpowered Modular Extension Blocks

FX1S FX1N FX2N FX2NC FX3U

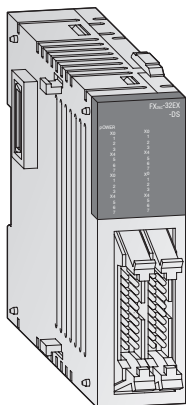

FX2NC-32EX-DS

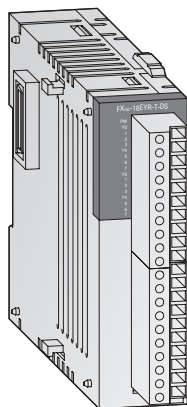

FX2NC-16EYR-T-DS

Modular Extension Blocks FX2NC

The FX2NC series extension blocks are available with 16 or 32 input/output points.

For modules with 16 outputs it is possible to choose between relay and transistor output type.

Special Features:

- Very compact dimensions
- LEDs for indicating the input and output status
- Removable terminal blocks for FX2NC-16EYR-T-DS and FX2NC-16EX-T-DS
- Adapter modules and system cabling sets available for units with ribbon cable connectors (transistor output types)

Specifications	FX2NC-16 EX-T-DS	FX2NC-16 EYR-T-DS	FX2NC-16 EX-DS	FX2NC-16 EYT-DSS	FX2NC-32 EX-DS	FX2NC-32 EYT-DSS
Electrical data						
Integrated inputs/outputs	16	16	16	16	32	32
Power supply	All modular extension units are supplied by the base unit.					
Inputs						
Integrated inputs	16	—	16	—	32	—
Input current	5	—	5	—	5	—
Min. current for logical 1	mA 3.5	—	3.5	—	3.5	—
Max. current for logical 0	mA 1.5	—	1.5	—	1.5	—
Isolation	Photocoupler isolation between input terminals and PC power for all base units.					
Response time	10 ms	—	10 ms	—	10 ms	—
Outputs						
Integrated outputs	—	16	—	16	—	32
Output type	—	Relay	—	Transistor (source)	—	Transistor (source)
ON voltage (max.)	V	Generally for relay version: < 240 V AC, < 30 V DC; for transistor version: 5 – 30 V DC				
Max. output current	A	2	—	0.1	—	0.1
- per output	A	4	—	0.8	—	0.8
- per group ^①	VA	80	—	2.4	—	2.4
Max. switching power	ms	10	—	< 0.2	—	< 0.2
Response time	Life of contacts (switching times) ^②	Same as base unit				
Mechanical data						
Connection type	Removable screw terminal blocks	Removable screw terminal blocks	Ribbon cable connector	Ribbon cable connector	Ribbon cable connector	Ribbon cable connector
Weight	kg 0.15	0.15	0.15	0.15	0.2	0.2
Dimensions (W x H x D)	mm 20.2 x 90 x 89	24.2 x 90 x 89	14.6 x 90 x 87	14.6 x 90 x 87	26.2 x 90 x 87	26.2 x 90 x 87
Order information	Art. no.	128152	128153	104503	104504	104505
						104506

① This limitation applies only per reference terminal for each group. Please observe the terminal assignments for the group identification.

② Not guaranteed by Mitsubishi Electric

■ Analog Output Modules

FX1S FX1N FX2N FX2NC FX3U

FX2N-2DA, FX2N-4DA, FX2NC-4DA

The analog output modules provide the user with 2 to 4 analog outputs. The modules convert digital values from the FX1N/FX2N/FX2NC/FX3U controller to the analog signals required by the process. The module can output both current and voltage signals.

Note: The FX2NC-4DA may only be used in combination with a FX2NC series base unit. When attaching a FX2N-2DA or FX2N-4DA to a FX2NC base unit, the interface adapter FX2N-CNV-IF is required.

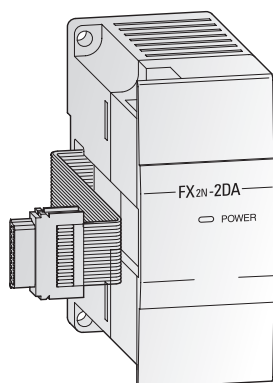

Specifications	FX2N-2DA	FX2N-4DA	FX2NC-4DA
Power supply	5 V DC/30 mA (from base unit); 24 V DC/85 mA (from base unit)	5 V DC / 30 mA (from base unit); 24 V DC / 200 mA	5 V DC / 30 mA (from base unit); 24 V DC / 130 mA
Analog channels			
inputs	—	—	—
outputs	2	4	4
Analog output range	0 – +10 V DC / 0 – +5 V DC / 4 – +20 mA	-10 – +10 V DC / 0 – +20 mA / 4 – +20 mA	-10 – +10 V DC / 0 – +20 mA / 4 – +20 mA
Resolution			
voltage	2.5 mV (12 bit)	5 mV (10 bit)	5 mV (10 bit)
current	4 μA (12 bit)	20 μA (11 bit + sign)	20 μA (11 bit + sign)
Fullscale overall accuracy	±1 %	±1 %	±0.5 – 1 %*
Related I/O points	8	8	8
Weight	kg 0.3	0.3	0.13
Dimensions (W x H x D)	mm 43 x 90 x 87	55 x 90 x 87	24.2 x 90 x 89
Order information	Art. no. 102868	65586	151234

* Dependent on the ambient temperature

■ Analog Input Modules

FX1S FX1N FX2N FX2NC FX3U

FX2N-2AD, FX2N-4AD, FX2NC-4AD, FX2N-8AD

The analog input modules provide the user with 2 to 8 analog inputs. The module converts analog process signals into digital values which are further processed by the MELSEC FX1N/FX2N/FX2NC/FX3U controller.

The actual values or mean values over several measurements may be output.

Note: The FX2NC-4AD may only be used in combination with a FX2NC series base unit. When attaching a FX2N-2AD, FX2N-4AD, or FX2N-8AD to a FX2NC base unit, the interface adapter FX2N-CNV-IF is required.

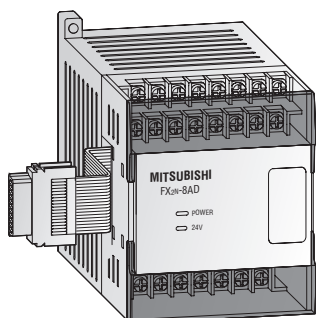
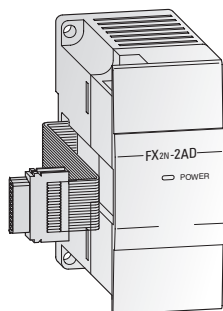

Specifications	FX2N-2AD	FX2N-4AD	FX2NC-4AD	FX2N-8AD
Power supply	5 V DC/20 mA (from base unit); 24 V DC/50 mA (from base unit)	5 V DC / 30 mA (from base unit); 24 V DC / 55 mA	5 V DC / 50 mA (from base unit); 24 V DC / 130 mA	5 V DC / 50 mA (from base unit); 24 V DC / 80 mA
Analog channels				
inputs	2	4	4	8
outputs	—	—	—	—
Analog input range	0 – +10 V DC / 0 – +5 V DC / 0/ 4 – +20 mA	-10 – +10 V DC / -20 – +20 mA / 4 – +20 mA	-10 – +10 V DC / -20 – +20 mA / 4 – +20 mA	-10 – +10 V DC / -20 – +20 mA / 4 – +20 mA
Resolution				
voltage	2.5mV, 1.25mV / 4 μA (12 bits)	5 mV (11 bit + sign)	0.32 mV (15 bit+sign)	0.63 mV (14 bit + sign)
current		20 μA (10 bit + sign)	1.25 μA (14 bit+sign)	2.5 μA (13 bit + sign)
Fullscale overall accuracy	±1 %	±1 %	±0.3 – 0.5 %*	±0.3 – 0.5 %*
Related I/O points	8	8	8	8
Weight	kg 0.3	0.3	0.13	0.4
Dimensions (W x H x D)	mm 43 x 90 x 87	55 x 90 x 87	20.2 x 90 x 89	75 x 105 x 75
Order information	Art. no. 102869	65585	151233	129195

* Dependent on the ambient temperature

Note: The FX2N-8AD can be configured to accept standard analog inputs as well as selected temperature inputs such as K, T or J type thermocouples.

■ Combined Analog I/O Modules

FX1S FX1N FX2N FX2NC FX3U

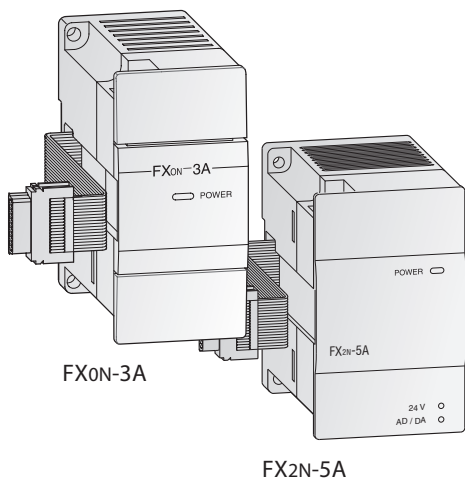

FX0N-3A, FX2N-5A

- The analog input/output modules are available in two different models. They provide the user with 2 or 4 analog inputs and 1 analog output. They serve for conversion of analog process signals into digital values, and vice versa.
- As of the FX2N-5A module the analog inputs can be selected between current or voltage input signals.

Note: The FX2N-5A may not be used in combination with a FX1N series base unit. When attaching one of these analog modules to a FX2NC base unit, the interface adapter FX2N-CNV-IF is required.

Specifications	FX0N-3A	FX2N-5A
Power supply	24 V DC / 90 mA (from base unit); 5 V DC / 30 mA (from base unit)	24 V DC / 90 mA; 5 V DC / 70 mA (from base unit)
Number of analog points	inputs	2
	outputs	1
Input (resolution)	voltage	0 – +10 V (8 bit), 0 – +5 V (8 bit)
	current	0/4 – +20 mA (8 bit)
	current	-10 – +10 V (15 bit + sign), -100 – +100 mV (11 bit + sign)
Output (resolution)	voltage	0 – +10 V (8 bit), 0 – +5 V (8 bit)
	current	4 – +20 mA (8 bit)
	current	0/4 – +20 mA (14 bit) -20 – +20 mA (14 bit + sign), 0/4 – +20 mA (14 bit)
Total accuracy	±1 %	±0.3 – 1 %*
Related I/O points	8	8
Weight	kg 0.2	0.3
Dimensions (W x H x D)	mm 43 x 90 x 87	55 x 90 x 87
Order information	Art. no. 41790	153740

*Dependent on the ambient temperature

■ Analog Temperature Input Modules

FX1S FX1N FX2N FX2NC FX3U

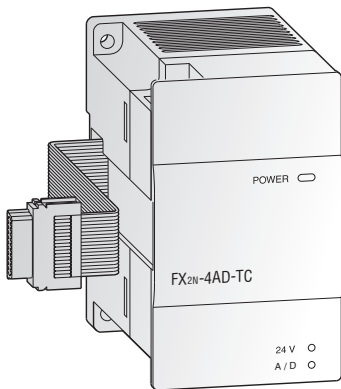

FX2N-4AD-TC, FX2N-4AD-PT, FX2N-2LC

- The analog input module for thermocouples FX2N-4AD-TC is used for processing temperatures. It has 4 independent inputs for detecting signals from thermocouples of types J and K. The type of thermocouple can be chosen independently for each point.
- The analog input module for Pt100 inputs FX2N-4AD-PT permits the connection of four Pt100 sensors to the FX2N/FX2NC/FX3U series controller.
- The temperature control module FX2N-2LC is equipped with two temperature input points and two transistor (open collector) output points. It is used to read temperature signals from thermocouples and Pt100 sensors, and performs PID output control

Note: The FX2N-2LC may not be used in combination with a FX1N series base unit. When attaching one of these modules to a FX2NC base unit, the interface adapter FX2N-CNV-IF is required.

Specifications	FX2N-4AD-TC	FX2N-4AD-PT	FX2N-2LC
Power supply	5 V DC / 40 mA (from base unit); 24 V DC / 60 mA	5 V DC / 30 mA (from base unit); 24 V DC / 50 mA	5 V DC / 70 mA (from base unit); 24 V DC / 55 mA
Analog inputs	4 (J or K type)	4 (Pt100 sensors)	2 points
Compensated temperature range	°C -100 – +600 (J type) / -100 – +1200 (K type)	-100 – +600	Thermocouple and Pt100 sensor
Digital outputs	-1000 – +6000 (J type) / -1000 – +12000 (K type)	-1,000 – 6,000 (12 bit conversion)	2 transistor output points
Resolution	0.3 (J type) / 0.4 (K type)	0.2 – 0.3 °C	0.1 °C or 1 °C
Total accuracy	±0.5% fullscale +1 °C	±1.0 % fullscale	±0.7 % fullscale (±0.3 % when ambient temperature is 23 °C ±5 °C)
Related I/O points	8	8	8
Weight	kg 0.3	0.3	0.3
Dimensions (W x H x D)	mm 55 x 90 x 87	55 x 90 x 87	55 x 90 x 87
Order information	Art. no. 65588	65587	129196

■ Analog Temperature Input Adapters

FX1S FX1N FX2N FX2NC FX3U

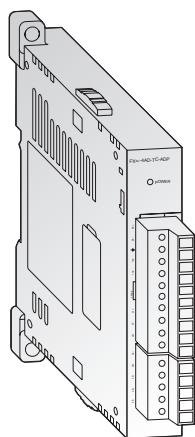

FX3U-4AD-TC-ADP

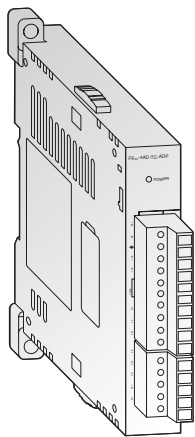

FX3U-4AD-PT-ADP

FX3U-4AD-TC-ADP, FX3U-4AD-PT-ADP

- The analog input adapter for thermocouples FX3U-4AD-TC-ADP is used for processing temperatures. It has 4 independent inputs for detecting signals from thermocouples of types J and K.
- The analog input adapter module for Pt100 inputs FX3U-4AD-PT-ADP permits the connection of four Pt100 sensors to the FX3U series controller.

Note: These adapters can only be used with the FX3U and they require a function extension board.

Specifications	FX3U-4AD-TC-ADP	FX3U-4AD-PT-ADP
Power supply	5 V DC / 15 mA (from base unit); 24 V DC / 45 mA	5 V DC / 15 mA (from base unit); 24 V DC / 50 mA
Analog inputs	4 (J or K type)	4 (Pt100 sensors)
Compensated temperature range	°C -100 – +600 (J type) / -100 – +1000 (K type)	-50 – +250
Digital outputs	-1000 – +6000 (J type) / -1000 – +10000 (K type)	-500 – +2500
Resolution	°C 0.3 (J type) / 0.4 (K type)	0.1
Total accuracy	±0.5 % fullscale	±0.5 – 1.0 % fullscale*
Related I/O points	0	0
Weight	kg 0.1	0.1
Dimensions (W x H x D)	mm 17.6 x 90 (106) x 89.5	17.6 x 90 (106) x 89.5
Order information	Art. no. 165273	165272

*Dependent on the ambient temperature

■ Analog I/O Adapters

FX1S FX1N FX2N FX2NC FX3U

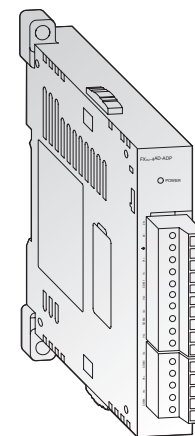

FX3U-4AD-ADP

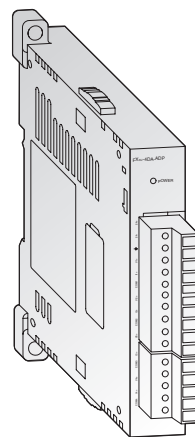

FX3U-4DA-ADP

FX3U-4AD-ADP, FX3U-4DA-ADP

- The FX3U-4AD-ADP adapter module for analog input is a special function adapter to add four analog input points to the FX3U PLC system.
- The FX3U-4DA-ADP adapter module for analog output is a special function adapter to add four analog output points to the FX3U PLC system.

Note: These adapters can only be used with the FX3U and they require a function extension board.

Specifications	FX3U-4AD-ADP	FX3U-4DA-ADP
Power supply	5 V DC / 15 mA (from base unit); 24 V DC / 40 mA	5 V DC / 15 mA (from base unit); 24 V DC / 150 mA
Analog channels	inputs 4	—
	outputs —	4
Analog range	0 – +10 V DC, 4 – +20 mA	0 – +10 V DC, 4 – +20 mA
Resolution	2.5 mV / 10 µA (12 bit / 11 bit)	2.5 mV / 4 µA (12 bit)
Overall accuracy	±0.5 %* / ±1 %	±0.5 %* / ±1 %
Related I/O points	0	0
Weight	kg 0.1	0.1
Dimensions (W x H x D)	mm 17.6 x 90 (106) x 89.5	17.6 x 90 (106) x 89.5
Order information	Art. no. 165241	165271

*Dependent on the ambient temperature and signal quality

High-Speed Counter Modules

FX1S FX1N FX2N FX2NC FX3U

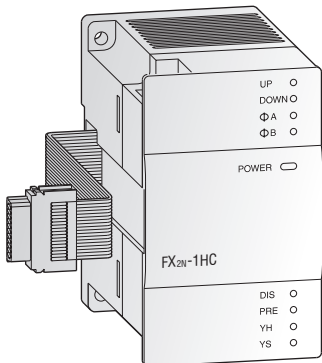

FX2N-1HC

In addition to the internal high-speed MELSEC FX counters, the high-speed counter module FX2N-1HC provides the user with an external counter. It counts 1- or 2-phase pulses up to a frequency of 50 kHz. The counting range covers either 16 or 32 bit.

The two integrated transistor outputs can be switched independently of one another by means of internal comparison functions. Hence, simple positioning tasks can also be realized economically. In addition, the FX2N-1HC can be used as a ring counter.

Note: When attaching the module to a FX2NC base unit, the interface adapter FX2N-CNV-IF is required.

Specifications	FX2N-1HC
Signal level	5, 12, 24 V DC / 7 mA
Power supply	5 V DC / 90 mA (from base unit)
Counter inputs	2 (1 phase) or 1 (2 phase)
Max. counting frequency	kHz 50
Input format	bit 16, 32
Type of counter	Up/down counter, ring counter
Counting range	16 bit 0 – 65535
	32 bit -2147483648 – +2147483647
Output type	2 x transistor (5 – 24 V DC; 0.5 A)
Related I/O points	8
Weight	kg 0.3
Dimensions (W x H x D)	mm 55 x 90 x 87
Order information	Art. no. 65584

High-Speed Counter Adapters

FX1S FX1N FX2N FX2NC FX3U

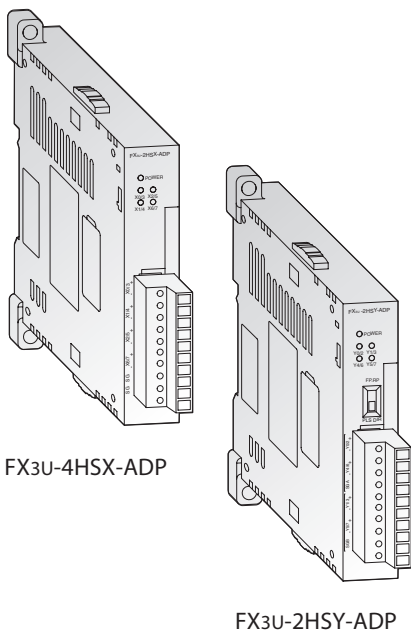

FX3U-4HSX-ADP

FX3U-2HSY-ADP

FX3U-4HSX-ADP, FX3U-2HSY-ADP

These adapter modules allow direct processing of positioning application data. The FX3U-4HSX-ADP provides high speed counter input up to 200 kHz while the FX3U-2HSY-ADP delivers 2 channels of pulse train outputs up to 200 kHz.

Specifications	FX3U-4HSX-ADP	FX3U-2HSY-ADP
Power supply	5 V DC / 30 mA (from base unit); 24 V DC / 30 mA (from base unit)	5 V DC / 30 mA (from base unit); 24 V DC / 60 mA (from base unit)
Maximum connectivity	2	2
Related I/O points	0	0
Counter	inputs 4	—
	outputs —	2
Max. counting frequency	inputs kHz 1 ch 1 input or 1 ch 2 inputs: 200	—
	outputs kHz 2 ch 2 inputs: 100	—
Input format	Differential line receiver (AM26C32 is suitable)	—
	Photocoupler isolation on inputs	—
Output format	—	Differential line driver (AM26C31 is suitable) Normal rotation pulse train, reverse pulse train or pulse train + one
Maximum cable length	m 10	10
Input potential	5 V DC	—
Output load	—	less than 25 mA
Weight	kg 0.08	0.08
Dimensions (W x H x D)	mm 17.6 x 90 (106) x 89.5	17.6 x 90 (106) x 89.5
Order information	Art. no. 165274	165275

■ Positioning Modules

FX1S FX1N FX2N FX2NC FX3U

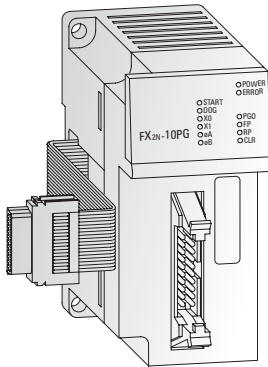

FX2N-1PG-E, FX2N-10PG

The positioning modules FX2N-1PG-E and FX2N-10PG are extremely efficient single-axis positioning modules for controlling either step drives or servo drives (by external regulator) with a pulse chain. They are very suitable for achieving accurate positioning in combination with the MELSEC FX series. The configuration and allocation of the position data are carried out directly via the PLC program.

A very wide range of manual and automatic functions are available to the user.

Note: When attaching one of the modules to a FX2NC base unit, the interface adapter FX2N-CNV-IF is required.

Specifications	FX2N-1PG-E	FX2N-10PG
Signal level for digital inputs	24 V DC / 40 mA	5 V DC / 100 mA; 24 V DC / 70 mA
Power supply	5 V DC / 55 mA (from base unit)	5 V DC / 120 mA (from base unit)
Accessible axes	1	1
Output frequency	pulse/s 10 – 100 000	1 – 1 000 000
Related I/O points	8	8
Weight	kg 0.3	0.2
Dimensions (W x H x D)	mm 43 x 90 x 87	43 x 90 x 87
Order information	Art. no. 65583	140113

■ Network Modules for CC-Link

□ FX1S ✓ FX1N ✓ FX2N ✓ FX2NC ✓ FX3U

CC-Link Master Module FX2N-16CCL-M

The CC-Link network enables the controlling and monitoring of decentralized I/O modules at the machine.

The CC-Link master module FX2N-16CCL-M is a special extension block which assigns an FX series PLC as the master station of the CC-Link system.

The setting of all modules within the network is handled directly via the master module.

Up to 15 remote stations and remote device stations can be connected to the master station as decentralized I/O stations. These remote stations can be up to 7 I/O modules and up to 8 intelligent modules. 2 master modules can be connected to one FX1N/FX2N/FX2NC base unit.

The maximum communications distance is 1200 m without repeater.

Note: When attaching this module to a FX2NC base unit, the interface adapter FX2N-CNV-IF is required. Refer to the Mitsubishi Electric Network catalog for I/O blocks and power supply units.

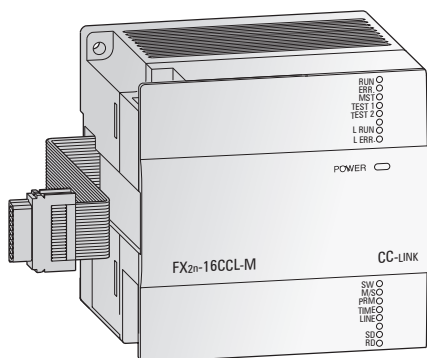

Specifications		FX2N-16CCL-M
Module type		Master station
Link points per station	I/O points	32
	register	8
Max. number of I/O points		128 (with FX1N PLC), 256 (with FX2N, FX2NC PLC), 384 (with FX3U PLC)*
Number of connectable modules		Max. 15
Related I/O points		8
Power supply		24 V DC / 150 mA
Weight		0.4
Dimensions (W x H x D)		85 x 90 x 87
Order information	Art. no.	133596

*Including I/O points in PLC and network.

CC-Link Communication Module FX2N-32CCL

The communication module FX2N-32CCL enables the user to connect to the CC-Link network with a superior PLC system as master CPU. This gives him access to the network of all MELSEC PLC systems and frequency inverters and to additional products from other suppliers.

Thus the network is expandable via the digital inputs/outputs of the FX modules to a maximum of 256 I/Os.

The buffer memory of the FX2N-32CCL is read and written by FROM/TO instructions.

The connection is to the extension bus on the right side of the controller.

Note: When attaching this module to a FX2NC base unit, the interface adapter FX2N-CNV-IF is required. Refer to the Mitsubishi Electric CC-Link, CC-Link/LT product catalog for I/O blocks and power supply units.

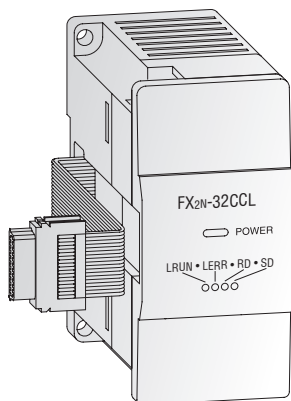

Specifications		FX2N-32CCL
Module type		Remote station
Link points per station	I/O points	32
	register	8
Max. number of I/O points		—
Number of connectable modules		—
Related I/O points		8
Power supply		5 V DC / max. 130 mA (from base unit); 24 V DC / 50 mA
Weight		0.3
Dimensions (W x H x D)		43 x 90 x 87
Order information	Art. no.	102961

■ Network Module for AS-Interface

FX1S FX1N FX2N FX2NC FX3U

AS-Interface Module FX2N-32ASI-M

The FX2N-32ASI-M serves as master module for the connection of the FX1N/FX2N/FX2NC and FX3U PLC to the AS-interface system. Up to 31 slave units with up to 4 inputs and 4 outputs can be controlled.

Note: When attaching this module to a FX2NC base unit, the interface adapter FX2N-CNV-IF is required.

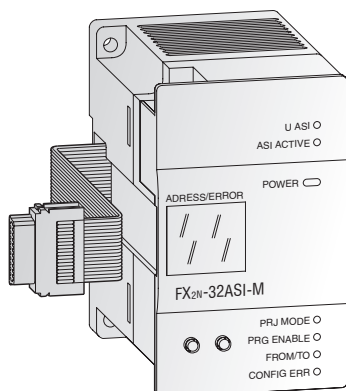

Specifications	FX2N-32ASI-M
Module type	Master module
Max. number of I/O points	128 (with FX1N PLC); 256 (with FX2N/FX2NC/FX3U PLC)*
Power supply	5 V DC / 150 mA (from base unit), 24 V DC / 70 mA external
Communication protocol	AS-interface standard
Communication speed	167 kbps
Method	APM method (Alternating Pulse Modulation)
Communication cable	AS-interface standard cable
Total extension distance	100 (up to 2 repeaters can be used on the system. The total extension distance may be extended by 100m for each repeater.) m
Max. number of controllable units	Up to 31 slave modules (up to 4 inputs / 4 outputs per slave)
I/O refresh time	Max. 5 ms
Network setup	2 key network setup
Display	7-segment display for status and diagnosis messages
Related I/O points	8
Weight	0.2 kg
Dimensions (W x H x D)	55 x 90 x 87 mm
Order information	Art. no. 103314

*Including I/O points in PLC and network.

Network Module for Ethernet

FX1S FX1N FX2N FX2NC FX3U

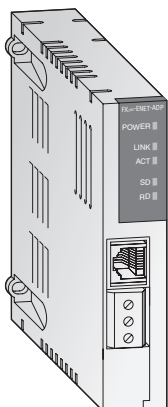

Ethernet Communications Adapter FX2NC-ENET-ADP

The FX2NC-ENET-ADP communications adapter is an Ethernet interface with 10BASE-T specifications for the FX1S, FX1N, FX2N and FX2NC series.

The FX2NC-ENET-ADP enables upload, download, monitor and test sequence of programs via Ethernet from a personal computer (GX Developer or MX Component and the virtual COM port driver installed).

Note: When connecting this adapter module to a FX1S or FX1N PLC the communications adapter FX1N-CNV-BD is required. When connecting this adapter module to a FX2N PLC the communications adapter FX2N-CNV-BD is required.

Specifications	FX2NC-ENET-ADP
Protocol	TCP/IP
No. of simultaneous open connections	1
Interface	IEEE802.3u (100BaseTX), IEEE802.3 (10BaseT)
Connector	RJ45 (to Ethernet), 3 screw terminals (to ground)
Max. transfer rate	10 Mbit/s
Cable	CAT5 STP or 3 STP
Related I/O points	0
Power supply	5 V DC / 135 mA (from base unit)
Weight	kg 0.1
Dimensions (W x H x D)	mm 19.1 x 90 x 78
Order information	Art. no. 157447

Network Module for Ethernet

FX1S FX1N FX2N FX2NC FX3U

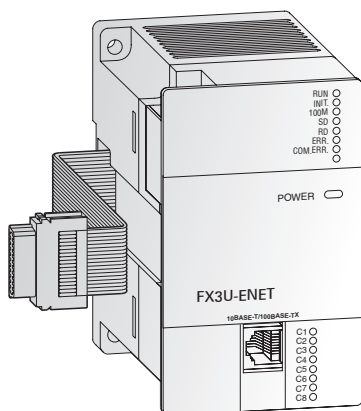

Ethernet Communications Module FX3U-ENET

The FX3U-ENET communications module provides the FX3U with a direct connection on to an Ethernet network.

With the FX3U-ENET installed an FX3U PLC can exchange data quickly and easily with process visualization systems in addition to supporting full program UP/DOWN load as well as comprehensive monitoring support. The module also supports Peer to Peer connection and MC Protocol. It is easily set-up with the FX Configurator-EN software.

Specifications	FX3U-ENET
Protocol	TCP/IP, UDP
Communication mode	Full-duplex / half-duplex
No. of simultaneous open connections	8
Fixed buffer communication	1023 word x 8
Communication with mail server	SMTP, POP3
Interface	IEEE802.3u (100BaseTX), IEEE802.3 (10BaseT)
Connector	RJ45
Max. transfer rate	100 Mbits/s, 10 Mbit/s
Max. segment length	m 100
Cable	CAT5 STP or 3 STP
Related I/O points	8
Power supply (5 V DC)	24 V DC / 240 mA (from base unit)
Weight	kg 0.3
Dimensions (W x H x D)	mm 55 x 90 x 87
Order information	Art. no. 166086

■ Network Module for Profibus/DP

FX1S FX1N FX2N FX2NC FX3U

Slave Module FX0N-32NT-DP

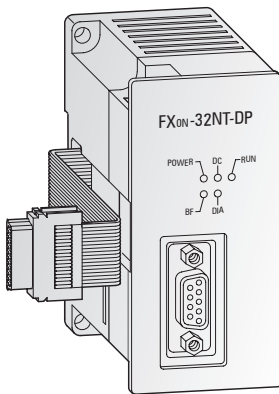

The FX0N-32NT-DP PROFIBUS/DP slave module enables you to integrate a MELSEC FX1N/FX2N/FX2NC or FX3U in an existing PROFIBUS/DP network.

This interface module provides your FX1N, FX2N, FX2NC or FX3U CPU with an intelligent PROFIBUS/DP link for the implementation of decentralised control tasks.

It links the system to the master PLC in the PROFIBUS/DP network for efficient and trouble-free data exchange.

Note: When attaching this module to a FX2NC base unit, the interface adapter FX2N-CNV-IF is required.

Specifications	FX0N-32NT-DP
Module type	Slave
Power supply	5 V DC / max. 170 mA (from base unit), 24 V DC / 60 mA
Interface	PROFIBUS/DP (with 9 pole D-SUB connector)
Communications speed	PROFIBUS standard
Profibus specifications	PROFIBUS standard
Communications distance	m Max. 1,200 (depends on communication speed)
Communication cable	PROFIBUS cable with 9-pin D-SUB connector
Related I/O points	8
Weight	kg 0.3
Dimensions (W x H x D)	mm 43 x 90 x 87
Order information	Art. no. 62125

■ Network Module for Profibus/DP

FX1S FX1N FX2N FX2NC FX3U

Master module FX3U-64DP-M

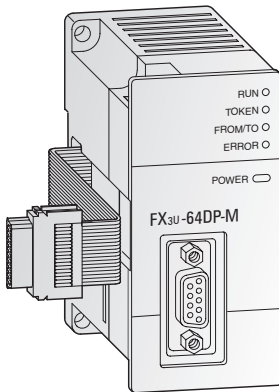

The FX3U-64DP-M PROFIBUS/DP master module enables you to integrate a MELSEC FX3U PLC system as a class 1 master of a PROFIBUS/DP network.

This interface module provides your FX3U CPU with an intelligent Profibus/DP link for the implementation of decentralised control tasks.

The FX3U Profibus/DP master provides comprehensive data and alarm processing to the Profibus/DP V1 standard. It is easily set up with the GX Configurator-DP software.

Specifications	FX3U-64DP-M
Module type	Master
Transmission type	Bus network
Transmission data	32 byte/slave (normal service mode) 244 byte/slave (extended service mode)
Interface	PROFIBUS/DP (with 9 pole D-SUB connector)
Max. number of master per configuration	1
Repeaters	3
Max. number of slaves	64
Communications speed	PROFIBUS standard
Communications distance	m Max. 1,200 (depends on communication speed)
Communication cable	PROFIBUS cable with 9-pin D-SUB connector
Related I/O points	8
Power supply	24 V DC / max. 155 mA (from base unit)
Weight	kg 0.2
Dimensions (W x H x D)	mm 43 x 90 x 87
Order information	Art. no. 166085

Remote I/O Station for PROFIBUS/DP

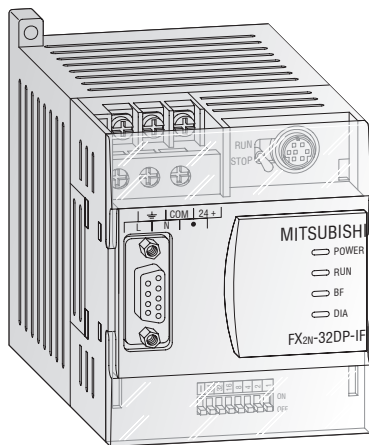

Remote I/O Station FX2N-32DP-IF

The remote I/O station FX2N-32DP-IF forms an extremely compact communication unit and provides a connection of I/O modules with up to 256 I/O points and/or up to 8 special function modules as an alternative.

It features an entire electrical isolation of the PROFIBUS/DP connector and of the sensor/actuator circuits.

The FX2N-32DP-IF includes a 240 V power supply unit and a 24 V service voltage terminal, e.g. for analog modules. The FX2N-32DP-IF-D is supplied with 24 V DC.

PROFIBUS data such as the baud rate or I/O data can be monitored directly with the programming software or on the hand-held programming unit FX-20P-E. This facilitates an easy error diagnosis directly on the remote I/O station.

Specifications	FX2N-32DP-IF	FX2N-32DP-IF-D
Power supply	100 – 240 V AC (+10 % / -15 %) 50/60 Hz	24 V DC (+20 % / -30 %)
Power consumption	30 VA	14 W
Internal current consumption	5 V DC / max. 220 mA (from base unit), 24 V DC / 500 mA	5 V DC / max. 220 mA (from base unit)
Interface (connectors)	9-pin D-SUB for PROFIBUS/DP, 8-pin Mini-DIN for PC or programming unit FX-20P-E	
Communication speed	distance	
	1200 m	kbps 9.6 / 19.2 / 45.45 / 93.75
	1000 m	kbps 187.5
	400 m	kbps 500
	200 m	kbps 1500
100 m	kbps 3000 / 6000 / 12000	
Communication distance	m	Max. 1200 (depends on communication speed)
Communication cable	PROFIBUS cable with 9-pin D-SUB connector	
Max. number of controllable I/O points	256	
Weight	kg	0.4
Dimensions (W x H x D)	mm	75 x 98 x 87
Order information	Art. no.	103705 142763

■ Network Module for DeviceNet

FX1S FX1N FX2N FX2NC FX3U

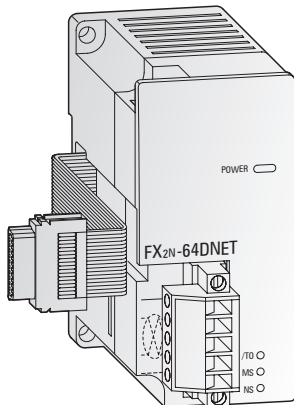

DeviceNet Slave Module FX2N-64DNET

The DeviceNet slave module FX2N-64DNET can be used to connect FX2N, FX2NC and FX3U programmable controllers to a DeviceNet network.

The FX2N-64DNET can communicate to the master by the master/slave communication (using the master/slave I/O connection), and to other nodes supporting the UCMM connection by client/server communication (using the UCMM connection).

The communication between the programmable controller and the internal buffer memory of the FX2N-64DNET is handled by FROM/ TO instructions.

Note: When attaching this module to a FX2NC base unit, the interface adapter FX2N-CNV-IF is required.

Specifications		FX2N-64DNET	
Module type		Slave (group 2)	
Node type		G2 Server	
Station numbers		0 – 63 points	
Supported communication speeds		kbps 125 / 250 / 500	
Communication data (open connection)	Master/slave	no. of connections	1 connection (group 2)
		transfer time-out	2,000 ms (ACK time-out)
	UCMM client/server	no. of connections	63/63 (group 1, 3)
		data length	Max. 64 bytes per connection
Communication data (I/O connection)		type	Polling, cyclic, change of state
		data length	Max. 64 bytes (fragmentation is possible)
Module ID code		K 7090	
Status displays		Power, module status, network status	
Related I/O points		8	
External power supply		24 V DC / 50 mA	
Internal power consumption (5 V DC)		mA	120
Weight		kg	0.2
Dimensions (W x H x D)		mm	43 x 90 x 87
Order information		Art. no.	131708

■ Network Module for CANopen

FX1S FX1N FX2N FX2NC FX3U

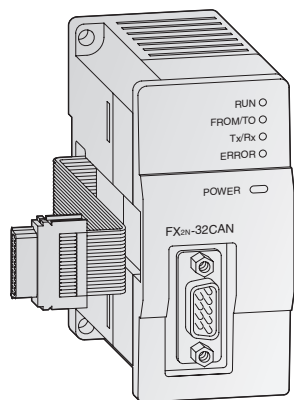

The FX2N-32CAN communications module makes it possible to connect an FX1N/FX2N/ FX2NC or FX3U PLC to an existing CANopen network.

In addition to real-time capabilities and high-speed data transfer at rates of up to 1Mbit/s the CANopen module also shines with high transfer reliability and simple network configuration. Up to 120 data words can be sent and received as process data objects (30 PDOs). The number of words that can be transmitted in each direction can be set between 1 and 120.

Communication with the module's memory buffer is performed with simple FROM/TO instructions.

Specifications		FX2N-32CAN	
Module type		CANopen master	
Power supply		5 V DC (via base unit)	
CAN standard		ISO 11898/1993	
CANopen standard by CiA		DS-301 version 3.0	
Additional CANopen features		NMT, Guarding, and Guarding request based on DS-302 V2.0. network variables based on DS-405 V1.0	
Max. nbr. of modules that can be connected to the network		30 without repeater; 127 with repeater	
Station numbers		1 – 127	
Supported baud rate		kBaud	10, 20, 50, 125, 250, 500, 800, 1000
Status displays		RUN, Error, Power, Network status	
Number of occupied I/O points		8	
Internal power consumption (5 V DC)		mA	290
External power supply		Not necessary	
Weight		kg	0.2
Dimensions (W x H x D)		mm	43 x 90 x 88.7
Order information		Art. no.	141179

■ Communications Adapter

FX1S FX1N FX2N FX2NC FX3U

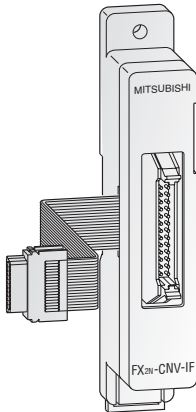

Interface Adapters FX2N-CNV-IF, FX2NC-CNV-IF

The FX2N-CNV-IF interface allows standard FX expansion blocks and special function modules to be connected to an FX2N PLC and the FX2NC-CNV-IF interface allows standard FX2N expansion blocks and special function modules to be connected to an FX2NC PLC.

Specifications	FX2N-CNV-IF	FX2NC-CNV-IF
Applicable for	Base units FX2N	Base units FX2NC
Bus connection	FX2N bus to FX bus	FX2NC bus to FX2N bus
Weight	kg 0.3	0.3
Dimensions (W x H)	mm 140 x 25 x 45	90 x 14.6 x 74
Order information	Art. no. 65598	104508

■ Communications Adapters

FX1S FX1N FX2N FX2NC FX3U

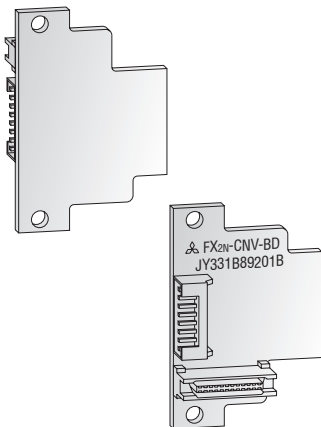

Communication Adapters FX1N-CNV-BD and FX2N-CNV-BD

The communication adapters FX□N-CNV-BD enable connection of the FX0N-232ADP and FX0N-485ADP special function modules to the left-hand side of the FX1N and FX2N base units.

Specifications	FX1N-CNV-BD	FX2N-CNV-BD
Applicable for	Base units FX1S/FX1N	Base units FX2N
General specifications	Conforms to FX1N/FX2N base units	
Power supply	Not necessary	
Related I/O points	0	0
Weight	kg 0.01	0.08
Dimensions (W x H)	mm 43 x 38 x (D) 14	54 x 35
Order information	Art. no. 130745	65598

■ Communications Modules

FX1S FX1N FX2N FX2NC FX3U

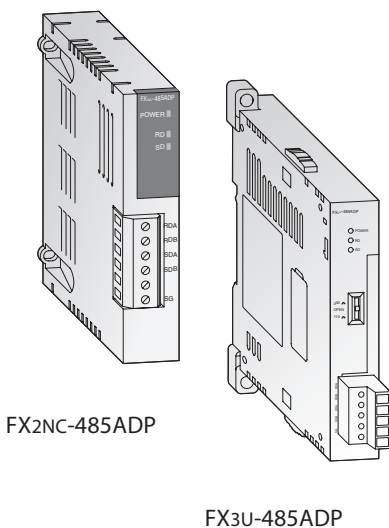

Communications Modules FX2NC-485ADP, FX3U-485ADP

The communication modules FX2NC-485ADP and FX3U-485ADP enable the configuration of 1:n multidrop, parallel link or peer-to-peer networks using the RS485 interface.

Note: the FX2NC-485ADP can only be used in combination with the FX2NC base units. FX3U-485ADP can only be used with the FX3U.

Specifications	FX2NC-485ADP	FX3U-485ADP
Power supply	5 V DC / max. 150 mA (from base unit)	5 V DC / 20 mA (from base unit)
Interface	RS485	
Communication speed*	kbps 0.3 – 19.2	0.3 – 115.2
Communication distance	m 500	500
Related I/O points	0	0
Weight	kg 0.1	0.08
Dimensions (W x H x D)	mm 19.1 x 90 x 78	17.6 x 90 (106) x 89.5
Order information	Art. no. 149111	165277

* Speed depends on communication method (Parallel link, N:N Network, No protocol, Dedicated protocol)

Interface Modules

✓ FX1S ✓ FX1N ✓ FX2N ✓ FX2NC ✓ FX3U

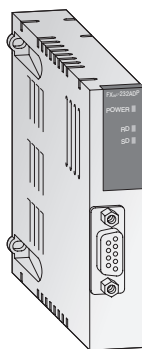

FX2NC-232ADP

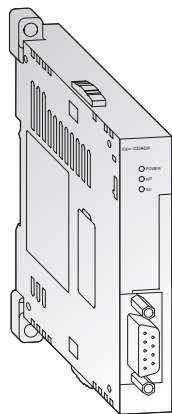

FX3U-232ADP

Active Data Interface Modules FX2NC-232ADP, FX3U-232ADP

The additional active data interface modules permit active communication between the PLC and surrounding RS232C peripherals. All device information can be sent or received via these interfaces.

The module is suitable for the connection of printers, bar code readers, PCs and other PLC systems. The communication is handled by the PLC program using the RS instruction.

The connection is to the communications bus on the left side of the controller. The internal serial RS422 interface is also fully available.

Note: The FX2NC-232ADP requires a FX2N-CNV-BD or FX1N-CNV-BD interface adapter when connecting to a FX1S, FX1N or FX2N base unit. The FX3U-232ADP can only be used with the FX3U and requires a function extension board.

Specifications	FX2NC-232ADP	FX3U-232ADP
Interface	RS232C with 9 pin D-SUB compact plug (photocoupler isolation)	
Power supply	5 V DC / 100 mA (from base unit)	5 V DC / 30 mA (from base unit)
Communication speed*	kbps 0.3 – 19.2	0.3 – 115.2
Communication distance	m Max. 15	Max. 15
Communication cable	Shielded cable	Shielded cable
Communication mode	Half duplex /Full Duplex	Half duplex /Full Duplex
Protocols	Computer link (dedicated protocol: format1, format4), no protocol, optional programming port	
Format	7 or 8 bits, parity: none/even/odd, stop bits: 1 or 2	7 or 8 bits, parity: none/even/odd, stop bits: 1 or 2
Related I/O points	0	0
Weight	kg 0.1	0.08
Dimensions (W x H x D)	mm 19.1 x 90 x 83	17.6 x 90 (106) x 81.5
Order information	Art. no. 149110	165276

* Speed depends on communication method (No protocol, Dedicated protocol, Protocol for programming tool)

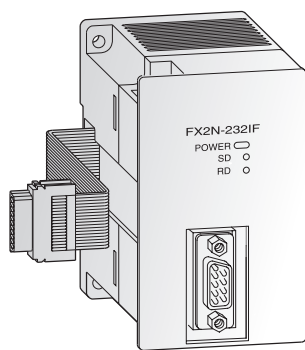

Interface Module FX2N-232IF

The interface module FX2N-232IF provides an RS232C interface for serial data communications with the MELSEC FX2N, FX2NC and FX3U.

Communication with PCs, printers, modems, barcode readers etc. is handled by the PLC program.

The send and receive data are stored in the FX2N-232IF's own buffer memory.

Changes at the user program are not possible via this interface module.

Note: When attaching this module to a FX2NC base unit, the interface adapter FX2N-CNV-IF is required.

Specifications	FX2N-232IF
Interface	RS232C with 9 pole D-SUB connector (photocoupler isolation)
Power supply	5 V DC / 40 mA (from base unit); 24 V DC / 80 mA
Communication speed	kbps 0.3 – 19.2
Communication distance	m Max. 15
Communication cable	Shielded cable
Communication mode	Full duplex
Protocols	Non protocol mode / start stop synchronisation
Send and receive buffer	512 byte each
Format	7 or 8 bits, parity none/even/odd, stop bits: 1 or 2
Related I/O points	8
Weight	kg 0.3
Dimensions (W x H x D)	mm 55 x 90 x 87
Order information	Art. no. 66640

Digital Extension Adapter Boards

FX1S FX1N FX2N FX2NC FX3U

Extension Adapters FX1N-4EX-BD, FX1N-2EYT-BD

The extension adapters for the FX1N series are available with 4 inputs or 2 outputs. They are installed directly in the controller of the FX1S or FX1N series and therefore do not require any additional installation space.

These adapters are especially advantageous when only few additional I/Os are required and there is not enough room for an adjacent module to be installed.

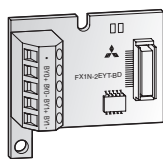

FX1N-2EYT-BD

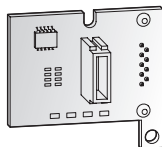

Connector side

Specifications	FX1N-4EX-BD	FX1N-2EYT-BD
Applicable for	Base units FX1S/FX1N	Base units FX1S/FX1N
Integrated inputs/outputs	4	2
Power supply	From base unit	From base unit
Integrated inputs	4	—
Input level	voltage	24 V DC (+20 % / -15 %)
	current	5 mA (24 V DC)
Integrated outputs	—	2
Output type	—	Transistor
Max. switching voltage	V	5 – 30 V DC
Weight	kg	0.02
Dimensions (W x H x D)	mm	43 x 38.5 x 22
Order information	Art. no.	139418
		139420

Analog Adapter Boards

FX1S FX1N FX2N FX2NC FX3U

Analog Adapter Boards FX1N-2AD-BD, FX1N-1DA-BD

The analog input adapter board FX1N-2AD-BD provides the user with 2 analog inputs. The board converts analog process signals into digital values which are further processed by the MELSEC FX1S/FX1N controller.

The analog adapter FX1N-1DA-BD provides the user with 1 analog output. The module converts digital values from the FX1S/FX1N controller to the analog signals required by the process.

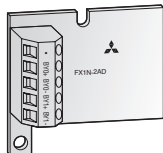

FX1N-2AD-BD

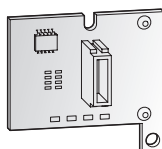

Connector side

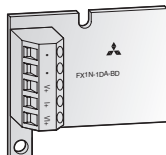

FX1N-1DA-BD

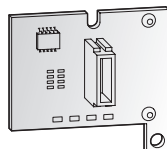

Connector side

Specifications	FX1N-2AD-BD	FX1N-1DA-BD
Applicable for	Base units FX1S/FX1N	Base units FX1S/FX1N
Power supply	From base unit	From base unit
Analog channels	inputs	2
	outputs	—
Output channels	—	1
Analog input range	0 – +10 V DC / 4 – +20 mA	0 – +10 V DC / 4 – +20 mA
Input resistance	voltage input	k Ω 300
	current input	Ω 250
External load	voltage output	k Ω —
	current output	Ω —
Resolution	2.5 mV (12 bits) / 8 μ A (11 bits)	2.5 mV (12 bits) / 8 μ A (11 bits)
Overall accuracy	\pm 1 %	\pm 1 %
Conversion speed	analog \rightarrow digital	1 program cycle
	digital \rightarrow analog	—
Related I/O points	0	0
Weight	kg	0.02
Dimensions (W x H x D)	mm	43 x 38.5 x 22
Order information	Art. no.	139421
		139422

■ Setpoint Adapter Boards

FX1S FX1N FX2N FX2NC FX3U

Analog Setpoint Adapters FX1N-8AV-BD and FX2N-8AV-BD

The FX□N-8AV-BD analog setpoint adapters enable the user to set 8 analog setpoint values. The analog values of the potentiometers are read into the controller and used as default setpoint values for timers, counters and data registers by the user's PLC programs. Setpoint value polling and the definition of the potentiometer scales are performed in the PLC program using the dedicated instructions VRRD/VRSC (FNC85/86).

The FX□N-8AV-BD analog setpoint adapters are installed in the expansion slot of the FX1S/FX1N/ FX2N CPU. No additional power supply is required for operation.

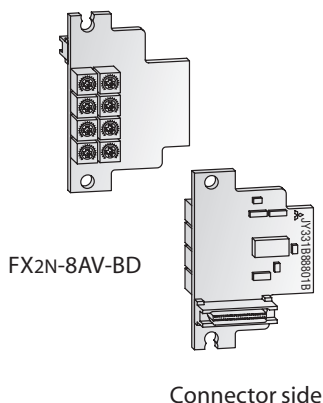

Specifications	FX1N-8AV-BD	FX2N-8AV-BD
Applicable for	Base units FX1S/FX1N	Base units FX2N
Power supply	From base unit	From base unit
Adjusting range	8 bit	8 bit
Related I/O points	0	0
Potentiometer evaluation	Via application instruction from the PLC CPU (FNC 85/86)	
Weight	kg 0.02	0.08
Dimensions (W x H x D)	mm 43 x 38.5 x 22	52 x 35 x 22
Order information	Art. no. 130744	65594

■ Communications Adapter Boards

FX1S FX1N FX2N FX2NC FX3U

Adapter Board FX3U-USB-BD

This adapter board allows direct USB 2.0 connection to the front of the FX3U PLC for program maintenance.

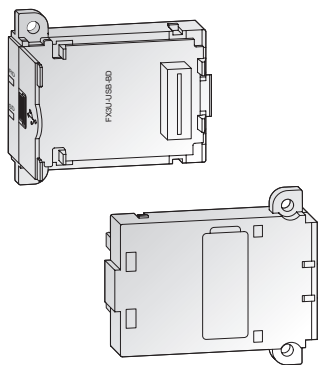

Specifications	FX3U-USB-BD
Applicable for	Base units FX3U
Power supply	5 V DC (from base unit)
Weight	kg 0.02
Dimensions (W x H x D)	mm 19.6 x 46.1 x 53.5
Order information	Art. no. 139421

■ Communications Adapter Boards

FX1S FX1N FX2N FX2NC FX3U

Communications Adapters FX1N-CNV-BD, FX2N-CNV-BD, FX3U-CNV-BD

The FX□N-CNV-BD adapters enable connection of the FX□□-□□□ADP special function modules to the left-hand side of the FX□□ base units.

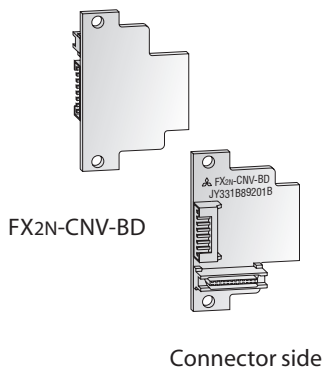

Specifications	FX1N-CNV-BD	FX2N-CNV-BD	FX3U-CNV-BD
Applicable for	Base units FX1S/FX1N	Base units FX2N	Base units FX3U
Weight	kg 0.01	0.08	0.01
Dimensions (W x H)	mm 43 x 38 x (D) 14	54 x 35	19.6 x 46.1 x 53.5
Order information	Art. no. 130745	65598	

Interface Adapters

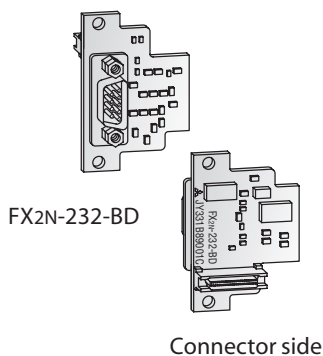

Interface Adapters FX1N-232-BD, FX2N-232-BD, FX3U-232-BD

The FX□□-232-BD interface adapters provide an RS232C interface for serial data communications with the MELSEC FX1S/FX1N/FX2N/FX3U.

Specifications	FX1N-232-BD	FX2N-232-BD	FX3U-232-BD
Applicable for	Base units FX1S/FX1N	Base units FX2N	Base units FX3U
Interface	RS232C with 9 pole D-SUB connector		
Power supply	5 V DC / 20 mA (from base unit)		5 V DC / 20 mA (from base unit)
Related I/O points	—		
Weight	kg 0.02	0.08	0.02
Dimensions (W x H x D)	mm 43 x 38.5 x 22	35 x 54 x 22	19.3 x 46.1 x 62.7
Order information	Art. no. 130743	65596	165281

Interface Adapters FX1N-422-BD, FX2N-422-BD, FX3U-422-BD

The FX□□-422-BD interface adapters provide a second RS422 interface for connection of an additional device to the controller (programming unit or operator terminal).

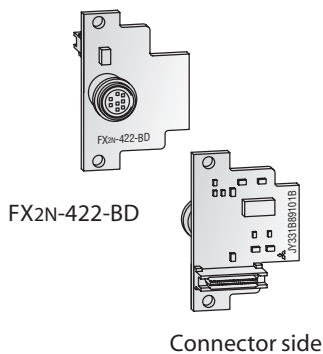

Specifications	FX1N-422-BD	FX2N-422-BD	FX3U-422-BD
Applicable for	Base units FX1S/FX1N	Base units FX2N	Base units FX3U
Interface	RS422 with 8 pole mini DIN connector		
Power supply	5 V DC / 60 mA (from base unit)		5 V DC / 20 mA (from base unit)
Related I/O points	—		
Weight	kg 0.01	0.08	0.02
Dimensions (W x H x D)	mm 43 x 38.5 x 20	35 x 54 x 22	19.6 x 46.1 x 53.5
Order information	Art. no. 130741	65595	165282

Interface Adapters FX1N-485-BD, FX2N-485-BD, FX3U-485-BD

The interface adapters FX□□-485-BD provide the controller with an additional RS485 interface. The adapter, which is simply inserted into the base unit's expansion slot, enables the configuration of RS485 1:n multidrop, parallel link or peer-to-peer networks with FX1S/FX1N/FX2N/FX3U systems.

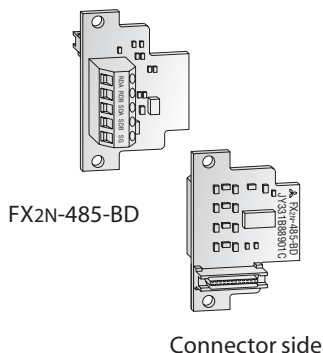

Specifications	FX1N-485-BD	FX2N-485-BD	FX3U-485-BD
Applicable for	Base units FX1S/FX1N	Base units FX2N	Base units FX3U
Interface	RS485 / RS422		
Power supply	5 V DC / 60 mA (from base unit)		5 V DC / 40 mA (from base unit)
Related I/O points	—		
Weight	kg 0.02	0.08	0.02
Dimensions (W x H x D)	mm 43 x 38.5 x 22	35 x 54 x 22	19.6 x 46.1 x 69
Order information	Art. no. 130742	65597	165283

Memory Media

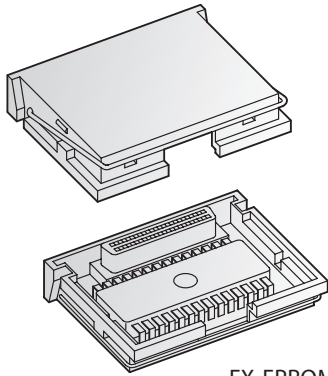

FX-EPROM-8

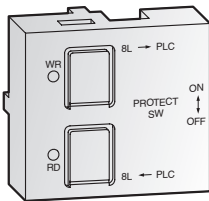

FX1N-EEPROM-8L



FX2NC-EEPROM-16

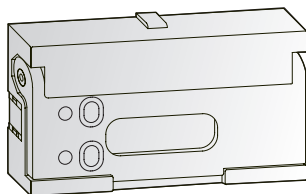

FX3U-FLROM-64L

Memory Cassettes for FX1S, FX1N and FX2N

All FX1S, FX1N and FX2N base units are equipped with a slot for the optional, robust FX memory cassettes. By connection of these memory cassettes, the internal memory of the controller is switched off and only the program specified in the respective memory cassette is run.

The memory size can be extended for all FX2N controllers up to 16,000 steps with the memory cassette FX-RAM-8.

The FX2N-ROM-E1 memory module simplifies the direct communication between the FX2N and the Mitsubishi Electric frequency inverters of the series FR-S500, FR-E500 and FR-A500. The FX2N-ROM-E1 technically corresponds to the FX-EEPROM-16.

Specifications	FX-RAM-8	FX-EPROM-8	FX-EEPROM-4
Applicable for	Base units FX2N	Base units FX2N	Base units FX2N
Memory type	RAM	EPROM	EEPROM
Size	8,000/16,000 steps	8,000/16,000 steps	4,000 steps
Protect switch	Not provided	Not provided	Provided
Order information	Art. no. 23823	23824	23825

Specifications	FX-EEPROM-8	FX1N-EEPROM-8L	FX-EEPROM-16	FX2N-ROM-E1
Applicable for	Base units FX2N	Base units FX1S/FX1N	Base units FX2N	Base units FX2N
Memory type	EEPROM	EEPROM	EEPROM	EPROM
Size	8,000 steps	2,000/8,000 steps	16,000 steps	16,000 steps
Protect switch	Provided	Provided	Provided	Not provided
Data transfer buttons	Not provided	Provided	Not provided	Not provided
Order information	Art. no. 23826	130746	65600	141528

Memory and Real-time Clock Cassette

All the FX2NC base units have a slot for adding a memory and real-time clock cassettes. The FX2NC-ROM-CE1 module contains both EEPROM memory and a real-time clock. The FX2NC-EEPROM-16 provides only memory, without the clock feature, while the FX2NC-RTC is a real-time clock cassette for the FX2NC PLCs without any additional memory.

Specifications	FX2NC-ROM-CE1	FX2NC-EEPROM-16	FX2NC-EEPROM16C	FX2NC-EEPROM-4C	FX2NC-RTC
Applicable for	Base units FX2NC	Base units FX2NC	Base units FX2NC	Base units FX2NC	Base units FX2NC
Memory type	EEPROM + RTC	EEPROM	EEPROM + RTC	EEPROM + RTC	RTC (real time clock)
Size	16,000 steps	16,000 steps	16,000 steps	4,000 steps	—
Protect switch	Not provided	Provided	Provided	Provided	Not provided
Order information	149016	104507	—	—	137206

Memory Cassettes for FX3U

The memory cassette can be installed at the main unit, and when installed, the memory cassette's internal program is used in place of the internal RAM memory.

The FX3U-FLROM-64L features additional data transfer buttons.

Specifications	FX3U-FLROM-16	FX3U-FLROM-64	FX3U-FLROM-64L
Applicable for	Base units FX3U	Base units FX3U	Base units FX3U
Number of steps	16,000	64,000	64,000
Memory type	Flash memory	Flash memory	Flash memory
Protect switch	Provided	Provided	Provided
Data transfer buttons	Not provided	Not provided	Provided
Dimensions (W x H x D)	mm 37 x 20 x 6.1	37 x 20 x 6.1	37 x 20 x 6.1
Order information	Art. no. 165278	165279	165280

Terminal Blocks

FX1N
 FX2N
 FX2NC
 FX3U

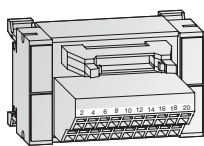

TB-20C

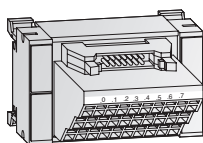

TB-□EX□

These terminal blocks are adapter modules that simplify the wiring of the inputs and outputs of the FX2NC units with ribbon cable connectors. This practical, time-saving wiring system also improves the performance of the outputs. Special terminal blocks are also available for the FX2N positioning modules with ribbon cable connectors.

Input blocks, output blocks and combined I/O blocks are available, with a choice of different terminal types.

The TB-□EX□ input blocks are fitted with rows of connectors for Kelvin terminals (24 V / 0 V), which make wiring quick and easy.

The TB-8EY-S and TB-8EY-C output blocks consist of 8 standard terminals and a system adapter. The standard terminals can be populated with relay or transistor elements, which makes it possible to configure the system for much higher output currents.

Preconfigured system cabling is available for all the terminal blocks (see next page).

Specifications	TB-8EX-S	TB-8EX-C	TB-16EX-S	TB-16EX-C
Block type	Input block	Input block	Input block	Input block
Number of inputs	8	8	16	16
Design	Initiator module with potential terminals			
Connection type	Screw terminals	Spring terminals	Screw terminals	Spring terminals
Application	FX2NC series base and extension modules with connectors			
Dimensions (W x H x D) mm	75 x 45 x 54	75 x 45 x 63	116 x 45 x 54	116 x 45 x 63
Order information	Art. no. 149144	149145	149021	149022
Accessories	Connection cable (refer to the following page)			

Specifications	TB-8EY-S	TB-8EY-C	TB-20-S	TB-20C
Block type	Output block	Output block	Input/output block	Input/output block
Channels	8	8	8 / 16	8 / 16
Design	Socket for relay or transistor elements		20 pin terminal module	
Connection type	Screw terminals	Spring terminals	Screw terminals	Spring terminals
Application	FX2NC series base and extension modules with connectors		FX2N series positioning modules	
Dimensions (W x H x D) mm	49.6 x 100 x 94	49.6 x 100 x 94	75 x 45 x 52	75 x 45 x 52
Order information	Art. no. 149044	149045	149148	149023
Accessories	Plug-in function elements (see below), connection cable (refer to the following page)		Connection cable (refer to the following page)	

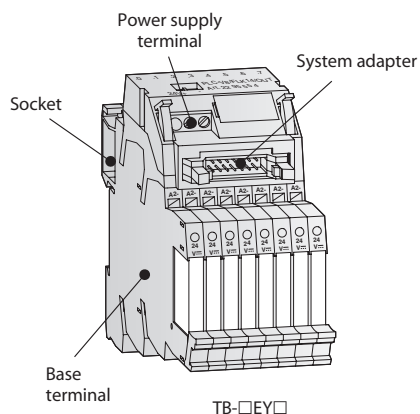

TB-□EY□

Construction of the base terminal

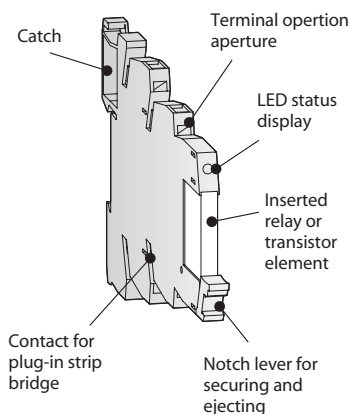

The transistor and relay elements are plugged directly into the standard terminals in the TB-8EY-S or TB-8EY-C modules. All the elements feature a status LED, protection against reverse polarity connection and a freewheeling diode.

Neighbouring terminals with identical voltages can be connected with plug-in strip bridge connectors, which can be cut to length as required.

Specifications	TB-8RELAY-6A	TB-8TRANSISTOR-2A
Output type	Relay with 1 switch-over contact	Transistor (with optocoupler)
Number of elements	8	8
Rated input voltage	24 V DC	24 V DC
Min./max. switching voltage	12 V AC/DC; 250 V AC/DC	3 V DC; 33 V DC
Limit permanent current	6 A	3 A (at 20 °C), 2 A (at 60 °C)
Max. breaking capacity	140 W (24 V DC), 1500 VA (250 V AC)	—
Ambient temperature	-20 – +60 °C	-20 – +60 °C
Order information	Art. no. 149034 (set with 8 elements)	149035 (set with 8 elements)
Accessories	Isolated strip bridge connector for potential isolation, TB-PIB-RD, colour red, art. no.: 149146; Isolated strip bridge connector for potential isolation, TB-PIB-BL, colour blue, art. no.: 149147; Isolation plate TB-SP for the lateral closing of the base terminal, art. no.: 149158	

■ Terminal Connection Cable

FX1S FX1N FX2N FX2NC FX3U

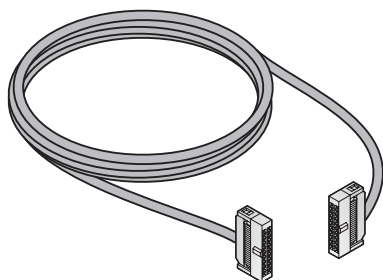

These preconfigured cables enable quick, error-free wiring of the terminal blocks of the FX2NC base and expansion units and the positioning modules of the FX2N series fitted with ribbon cable connectors.

The cables are available in a choice of lengths between 1 and 5 m. Other lengths are also possible by special order.

Specifications	TB-EX-CAB-1M	TB-EX-CAB-3M	TB-EX-CAB-5M
Application	For TB-□EX□ and TB-20-□ (1:1 cable)		
Length	m 1	3	5
Order information	Art. no. 149038	149039	149040

Specifications	TB-EY-CAB-1M	TB-EY-CAB-3M	TB-EY-CAB-5M
Application	For 2 x terminal blocks TB-8EY-S or TB-8EY-C (Y cable)		
Length	m 1	3	5
Order information	Art. no. 149041	149042	149043

■ Connection terminals

FX1S FX1N FX2N FX2NC FX3U

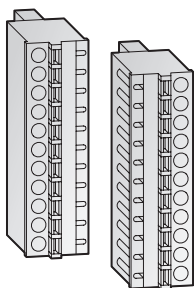

The base unit FX2NC-16MR-T-DS and the extension units FX2NC-16EX-T-DS and FX2NC-16EYR-T-DS are fitted with screw terminals as standard equipment.

These plug-in terminals can easily be replaced with spring terminals if required. Two replacement terminal units are required for each module with 16 I/Os.

Specifications	TB-CON10-C	TB-CON-11C
Number of terminal points	10	11
Connection type	Spring terminals	Spring terminals
Application	Extension units FX2NC-16EX-T-DS and FX2NC-16EYR-T-DS	Base unit FX2NC-16MR-T-DS
Dimensions (W x H x D)	mm 12.5 x 39 x 21	12.5 x 43 x 21
Order information	Art. no. 149036	149037

■ 24 V Power Supply Unit

FX1S FX1N FX2N FX2NC FX3U

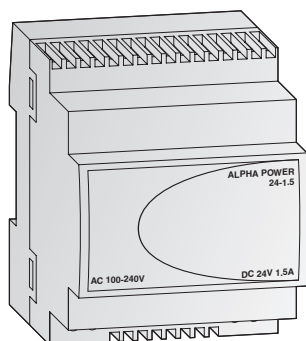

The Alpha Power is a convenient power supply for the 24 V units and other external devices. It comes with a DIN rail mounting system and its dimensions are matched to those of the MELSEC FX family.

Two Alpha Power units can be installed together for redundant mode operation or connected in parallel for more power. The units have an integrated thermal overload protection circuit.

Specifications	ALPHA POWER 24-1,4
General specifications	Conforms to FX family base units
Nominal input voltage	100–240 V (45 – 65 Hz)
Output voltage	24 V DC (+/-3%)
Nominal output current	1.5 A (at T = 55 °C), 2.0 A (at T = 40 °C)
Max. output current	2 A (110 V AC), 4 A (230 V AC)
Application	Power supply for 24 V DC base units
Ambient temperature	-25 – +55 °C (operation), -40 – +85 °C (storage)
Ambient humidity	Max. 95% (no condensation)
Weight	kg 0.2
Dimensions (W x H x D)	mm 71 x 90 x 57.8
Order information	Art. no. 149046

Cables

FX1S FX1N FX2N FX2NC FX3U

FX Series connection cables

The cable listed in the following tables are used for FX Series PLC programming, positioning applications, block connections and interface conversion.

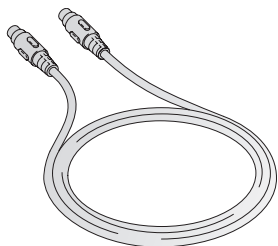

FX-20P-CAB0

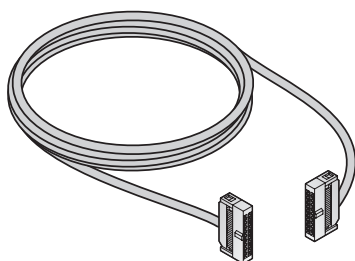

FX-16E-500CAB

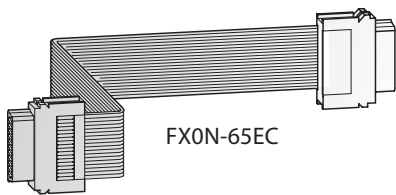

FX0N-65EC

Connection cable for RS232C peripherals

Specifications	F2-RS-5CAB	F2-232CAB-1	FX-232CAB-1
Application	FX2N-1RM to resolver	PC to FX-232AWC-H	PC to GOT
Length	m 5.0	3.0	3.0
Order information	Art. no. 76160	76163	124972

Connection cable for RS-422 peripherals

Specifications	FX-422CAB0	FX-422CAB	FX-422CAB-150
Application	FX-232AWC-H to FX□ PLC	FX-232AWC-H to FX PLC	FX-232AWC-H to FX PLC
Length	m 1.5	0.3	1.5
Order information	Art. no. 76094	25949	—

Connection cable for programming unit

Specifications	FX-20P-CAB0	FX-20P-CAB	FX-20P-CADP
Application	FX-20P-G to FX□ PLC	FX-20P-E to FX PLC	FX-20P-CAB to FX□ PLC
Length	m 1.5	1.5	0.3
Order information	55917	30815	31870

Connection cable for extension bus

Specifications	FX0N-65EC
Application	PLC bus cable
Length	m 0.65
Order information	Art. no. 45348

Interface converter

Specifications	FX-USB-AW	FX-232AWC-H
Application	USB to RS422 converter	RS422 to RS232C converter
Dimensions (W x H x D in mm)	m 0.063 + 3.0	25 x 80 x 60
Order information	Art. no. 165288	159642

Backup Batteries

FX1S FX1N FX2N FX2NC FX3U

Batteries

The battery buffers the internal RAM of the MELSEC PLC in the event of a voltage failure.

The battery F2-40BL can be used for all base units of the MELSEC FX2N series.

The battery FX2NC-32BL is suitable for all base units of the MELSEC FX2NC series and for the positioning modules FX2N-20GM.

The battery FX3U-32BL can be used for all base units of the MELSEC FX3U series.

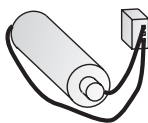

F2-40BL

Specifications	F2-40BL	FX2NC-32BL	FX3U-32BL
Applicable for	Base units FX2N	Base units FX2NC and FX2N-20GM module	Base unit FX3U
Order information	Art. no. 5142	128725	165286

■ Display Modules

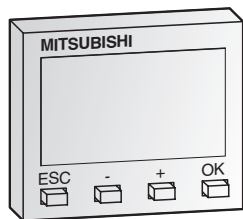

Display Module FX1N-5DM

The display module is inserted directly into the FX1S and FX1N series controllers and enables monitoring and editing of the data stored in the PLC.

The display module e.g. can be used instead of digital switches and external 7-segment displays in very confined areas.

Specifications	FX1N-5DM	
Applicable for	Base units FX1S/FX1N	
Display	LCD (with backlight)	
Power supply	5 V DC ±5 % (from base unit)	
Current consumption	mA	110
Weight	kg	0.02
Dimensions (W x H x D)	mm	40 x 32 x 17
Order information	Art. no.	129197

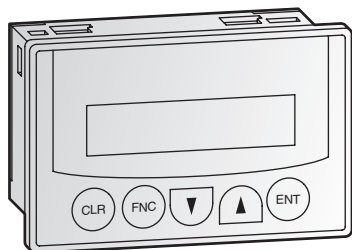

Control and Display Panel FX-10DM-E

The control and display panel FX-10-DM-E provides a key-oriented user-interface and enables you to monitor and edit process data in the PLC.

The display is arranged in 2 rows of 16 characters each. Functions can be invoked and values can be edited using the panel keys.

Specifications	FX-10DM-E	
Applicable for	All base units FX1S/FX1N/FX2N/FX3U	
Display	LCD (with backlight)	
Resolution	2 x 16 signs (80 x 16 pixels)	
Power supply	5 V DC ±5 % (from base unit)	
Current consumption	mA	220
Weight	kg	0.02
Dimensions (W x H x D)	mm	96 x 62 x 32
Order information	Art. no.	132600

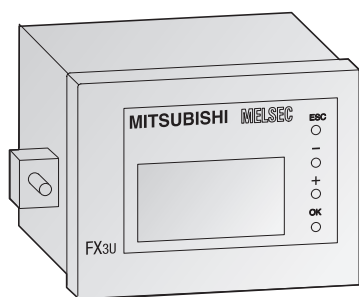

Panel FX3U-7DM with built-in holder FX3U-7DM-HLD

Control and Display Panel FX3U-7DM, Holder FX3U-7DM-HLD

The FX3U-7DM display module can be incorporated in the main unit, or can be installed in the enclosure using the FX3U-7DM-HLD display module holder.

Specifications	FX3U-7DM	FX3U-7DM-HLD
Applicable for	Base units FX3U	Base units FX3U
Display	16 letters x 4 lines	—
Resolution	—	—
Power supply	5 V DC (from base unit)	
Current consumption	mA	20
Extension cable	—	Included
Weight	kg	0.02
Dimensions (W x H x D)	mm	48 x 35 x 11.5
Order information	Art. no.	165268
		165287

Terminal Assignment of the Master Controllers and Extension Modules ALPHA XL

AL2-14M□-□

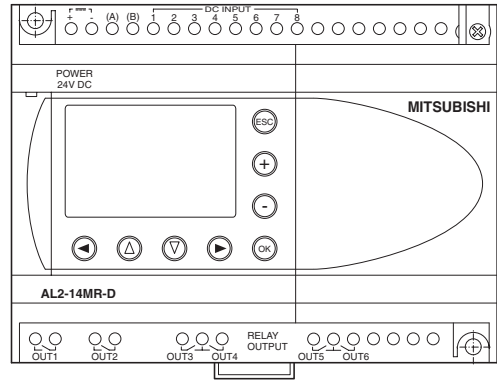
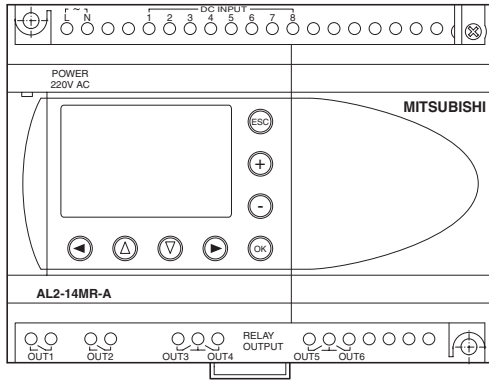

AL2-24M□-□

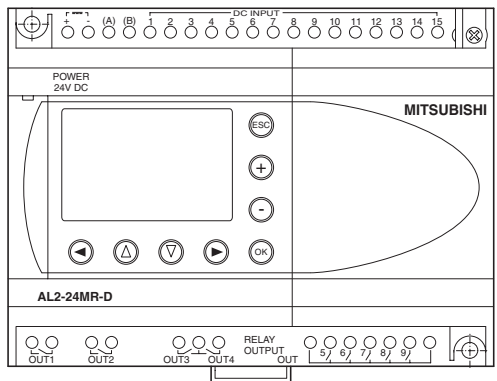
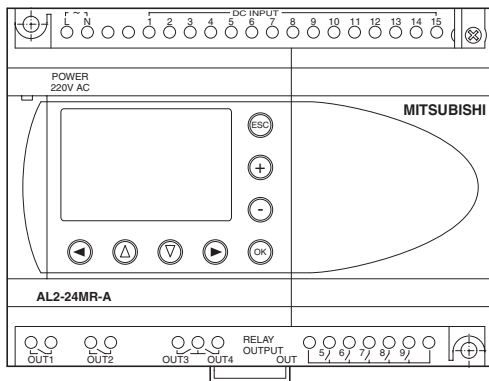

AL2-4EX

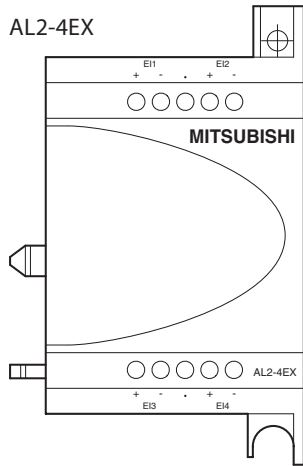

AL2-4EX-A2

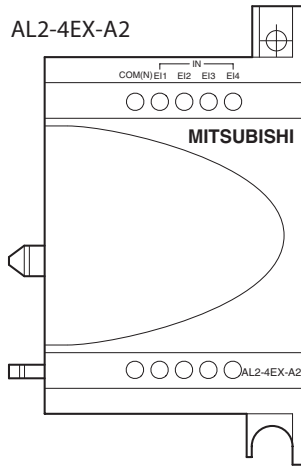

AL2-4EYT

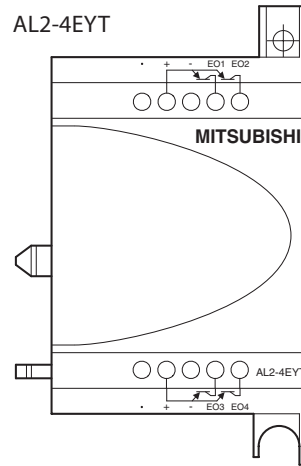

AL2-4EYR

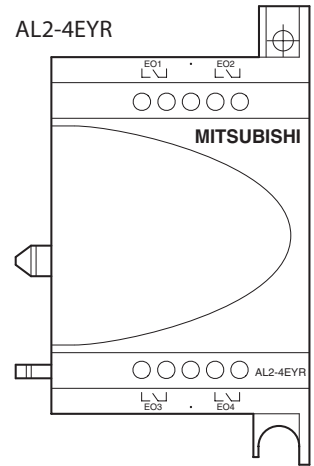

AL2-2DA

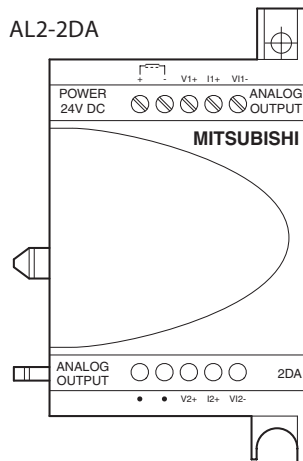

AL2-2PT-ADP

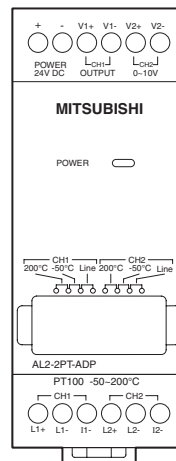

AL2-2TC-ADP

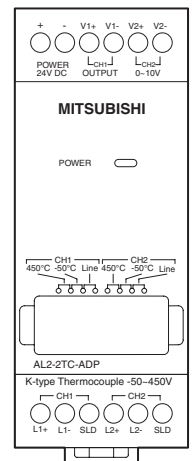

■ Base Units MELSEC FX1s

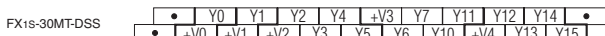
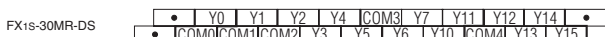
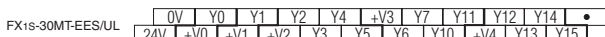
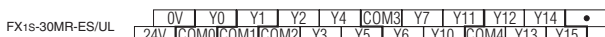
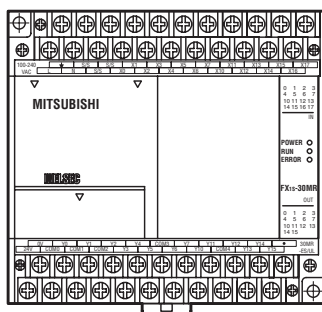
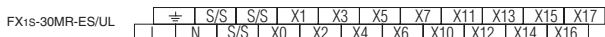
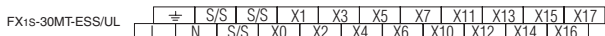
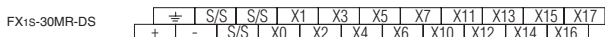
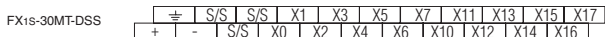
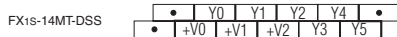
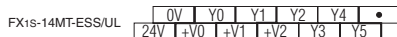
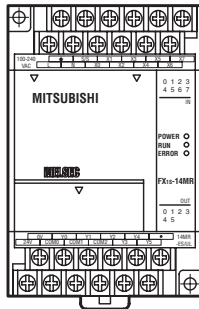
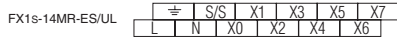
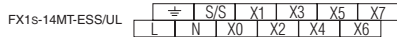
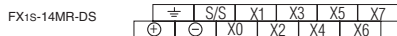
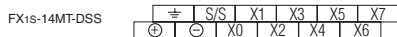
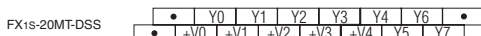
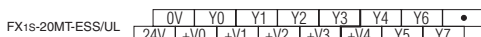
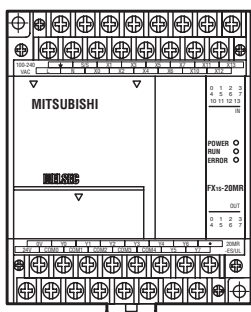
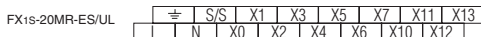
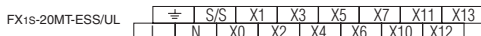
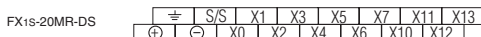
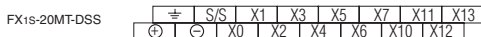
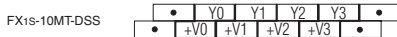
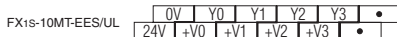
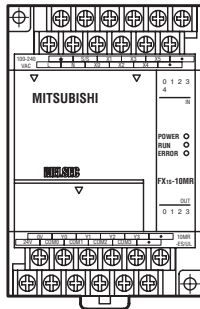
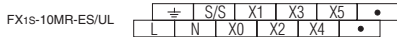
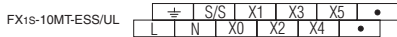
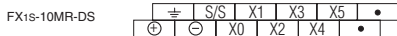
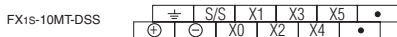

Base Units MELSEC FX1N

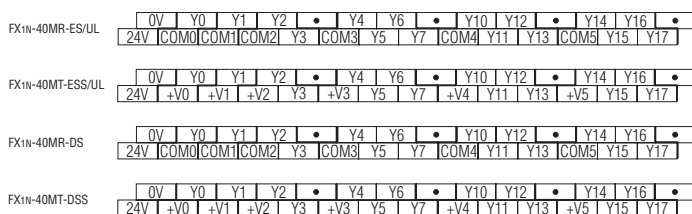
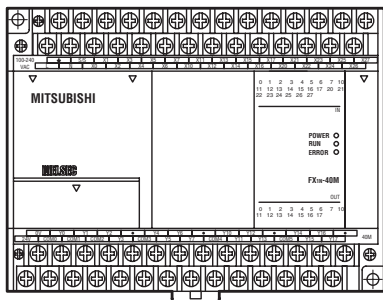
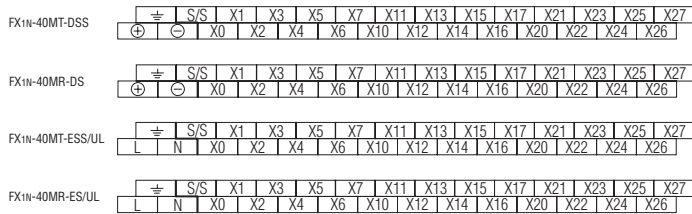
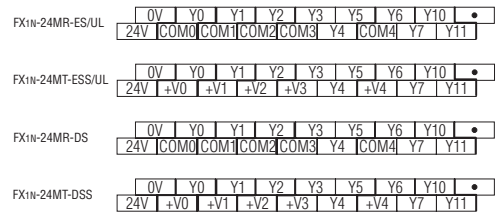
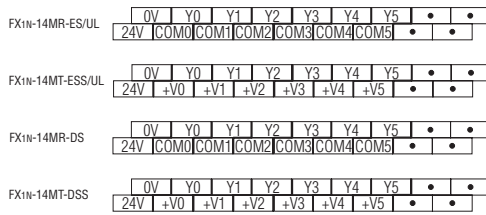
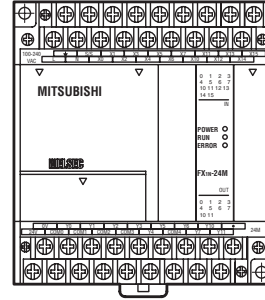
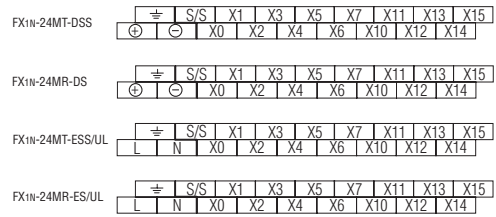
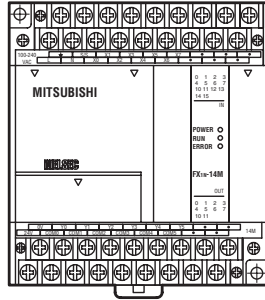
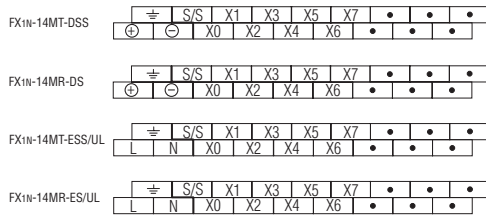

■ Base Units MELSEC FX1N

FX1N-60MT-DSS	⊕	S/S	X1	X3	X5	X7	X11	X13	X15	X17	X21	X23	X25	X27	X31	X33	X35	X37	X41	X43
	⊖		X0	X2	X4	X6	X10	X12	X14	X16	X20	X22	X24	X26	X30	X32	X34	X36	X40	X42

FX1N-60MR-DS	⊕	S/S	X1	X3	X5	X7	X11	X13	X15	X17	X21	X23	X25	X27	X31	X33	X35	X37	X41	X43
	⊖		X0	X2	X4	X6	X10	X12	X14	X16	X20	X22	X24	X26	X30	X32	X34	X36	X40	X42

FX1N-60MT-ESS/UL	⊕	S/S	X1	X3	X5	X7	X11	X13	X15	X17	X21	X23	X25	X27	X31	X33	X35	X37	X41	X43
	L	N	X0	X2	X4	X6	X10	X12	X14	X16	X20	X22	X24	X26	X30	X32	X34	X36	X40	X42

FX1N-60MR-ES/UL	⊕	S/S	X1	X3	X5	X7	X11	X13	X15	X17	X21	X23	X25	X27	X31	X33	X35	X37	X41	X43
	L	N	X0	X2	X4	X6	X10	X12	X14	X16	X20	X22	X24	X26	X30	X32	X34	X36	X40	X42

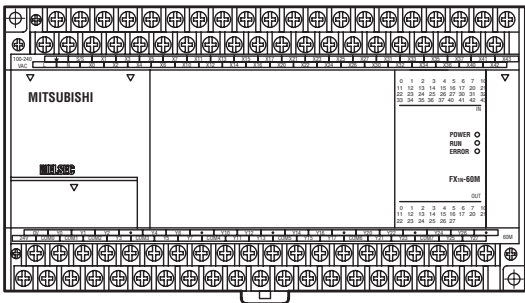

FX1N-60MR-ES/UL	0V	Y0	Y1	Y2	•	Y4	Y6	•	Y10	Y12	•	Y14	Y16	•	Y20	Y22	•	Y24	Y26	•
	24V	COM0	COM1	COM2	Y3	COM3	Y5	Y7	COM4	Y11	Y13	COM5	Y15	Y17	COM6	Y21	Y23	COM7	Y25	Y27

FX1N-60MT-ESS/UL	0V	Y0	Y1	Y2	•	Y4	Y6	•	Y10	Y12	•	Y14	Y16	•	Y20	Y22	•	Y24	Y26	•
	24V	+V0	+V1	+V2	Y3	+V3	Y5	Y7	+V4	Y11	Y13	+V5	Y15	Y17	+V6	Y21	Y23	+V7	Y25	Y27

FX1N-60MR-DS	0V	Y0	Y1	Y2	•	Y4	Y6	•	Y10	Y12	•	Y14	Y16	•	Y20	Y22	•	Y24	Y26	•
	24V	COM0	COM1	COM2	Y3	COM3	Y5	Y7	COM4	Y11	Y13	COM5	Y15	Y17	COM6	Y21	Y23	COM7	Y25	Y27

FX1N-60MT-DSS	0V	Y0	Y1	Y2	•	Y4	Y6	•	Y10	Y12	•	Y14	Y16	•	Y20	Y22	•	Y24	Y26	•
	24V	+V0	+V1	+V2	Y3	+V3	Y5	Y7	+V4	Y11	Y13	+V5	Y15	Y17	+V6	Y21	Y23	+V7	Y25	Y27

Base Units MELSEC FX2N

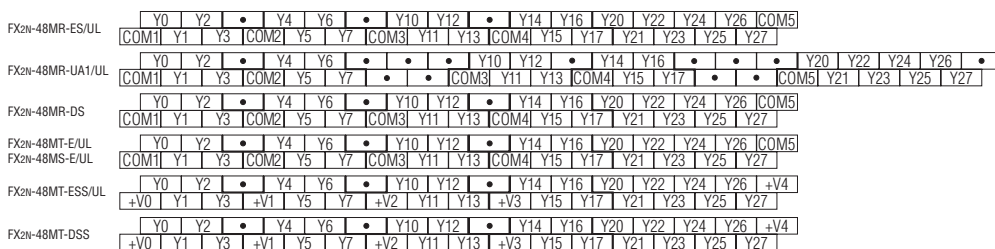
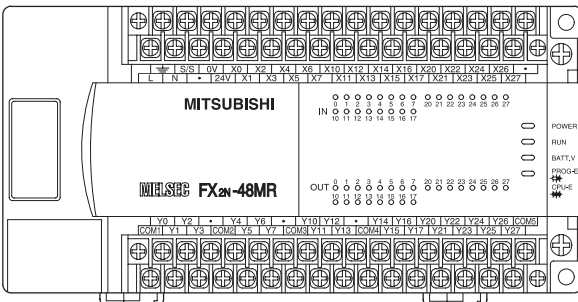
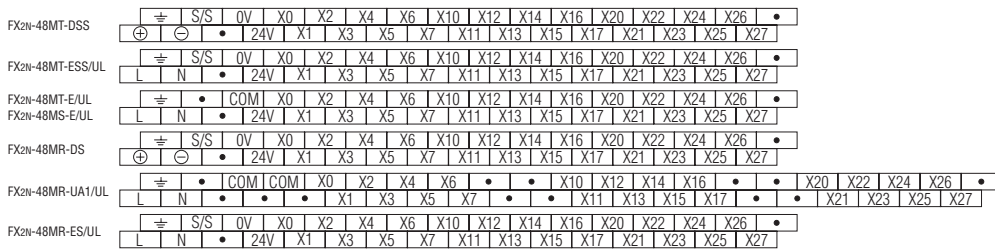
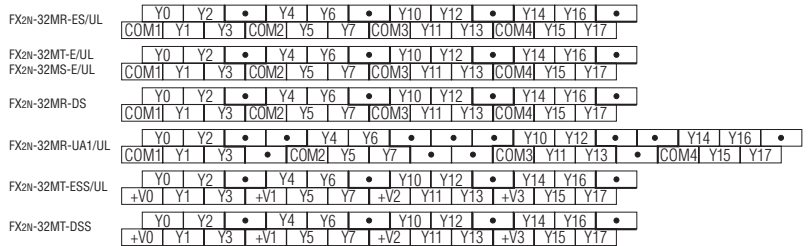
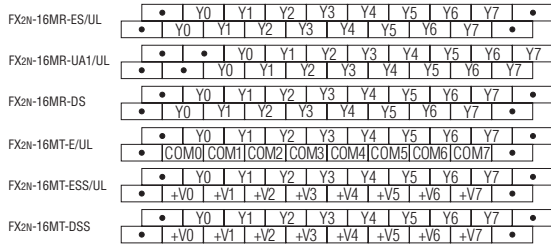
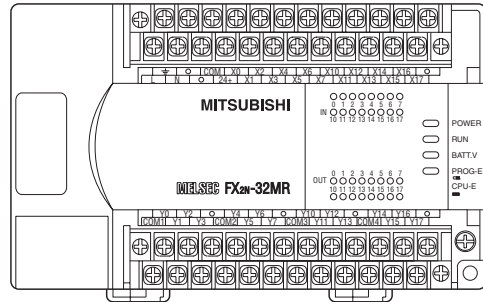
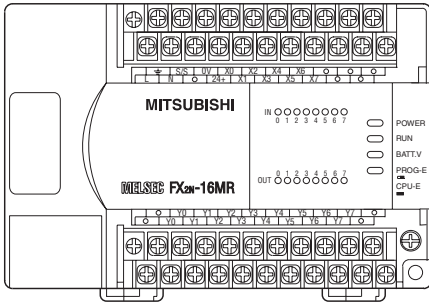
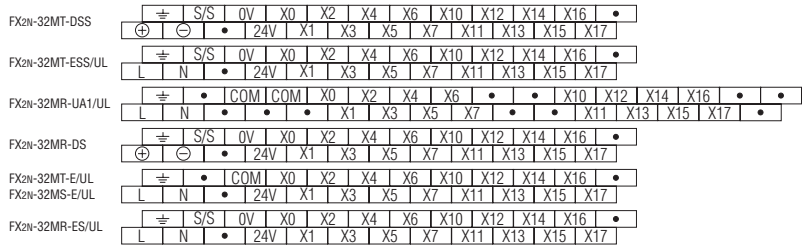
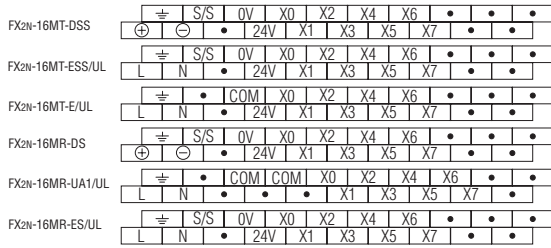

6

TERMINALS & DIMENSIONS

■ Base Units MELSEC FX2N

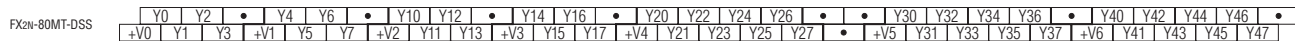
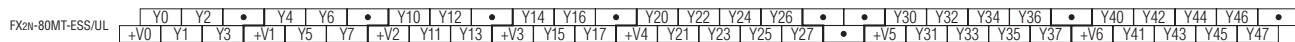
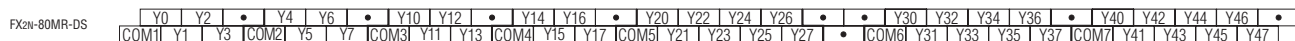
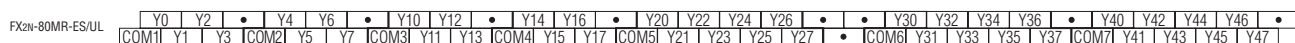
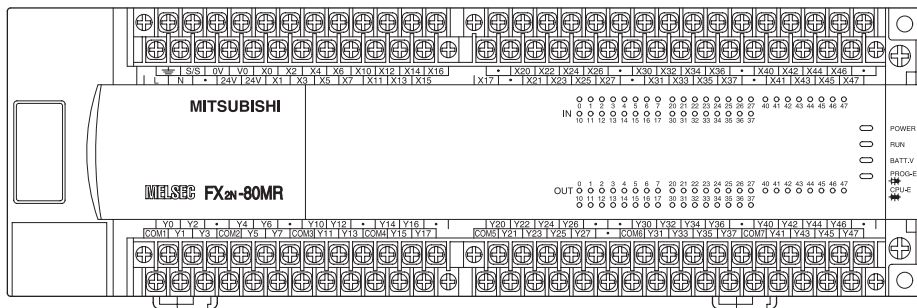
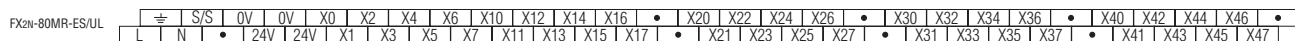
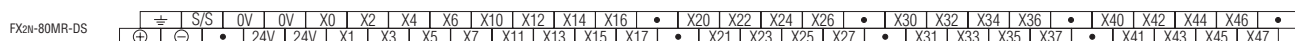
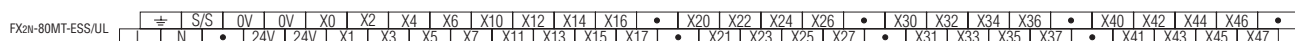
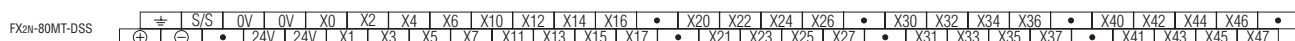
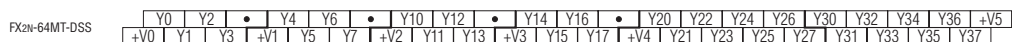
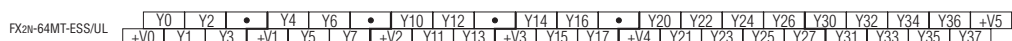
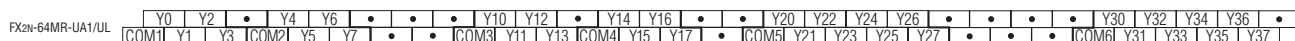
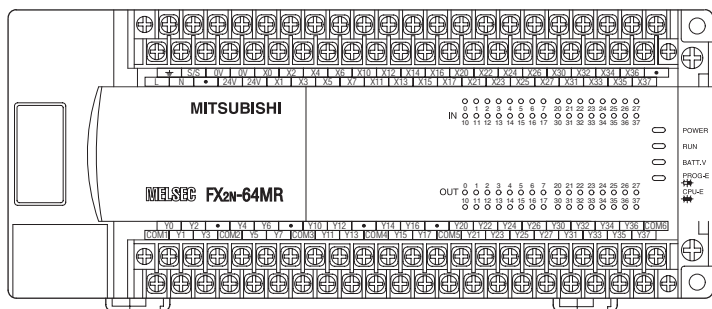
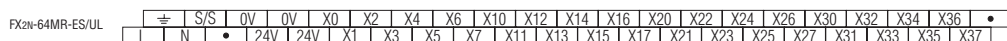
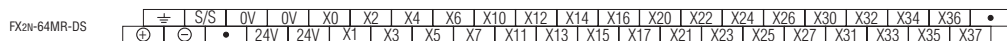
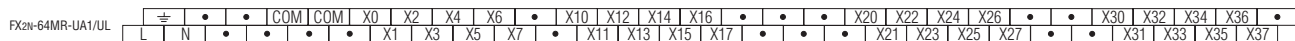
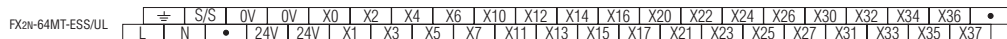
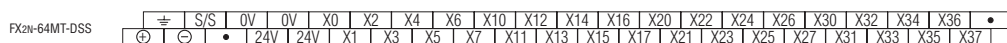

Base Units MELSEC FX2N

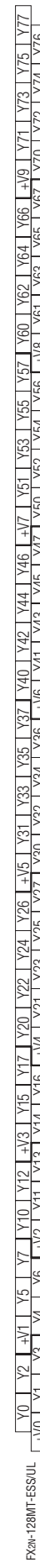
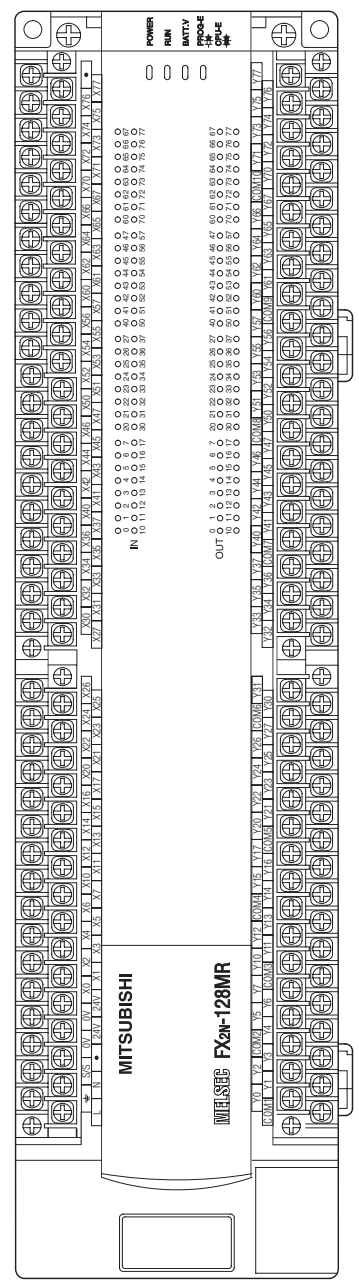

■ Base Units MELSEC FX2NC

FX2NC-16MT-DSS

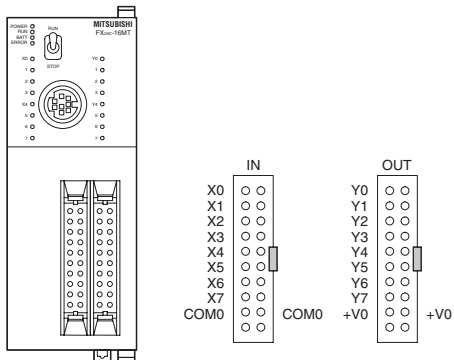

FX2NC-16MT-DS/UL

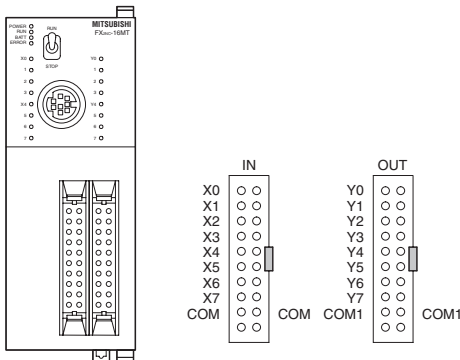

FX2NC-16MR-T-DS

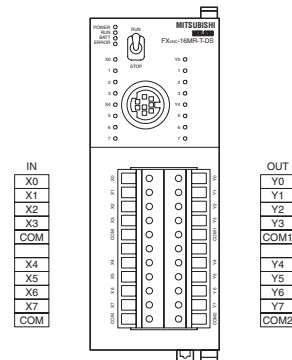

FX2NC-32MT-DSS

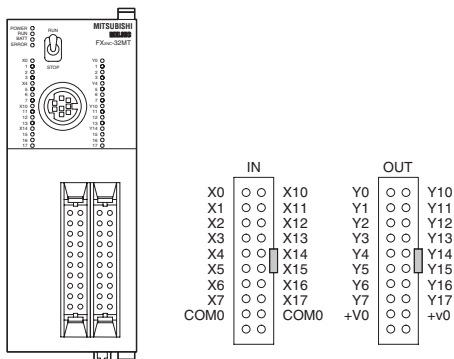

FX2NC-32MT-D/UL

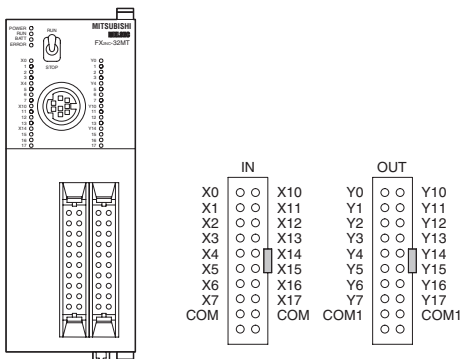

FX2NC-64MT-DSS

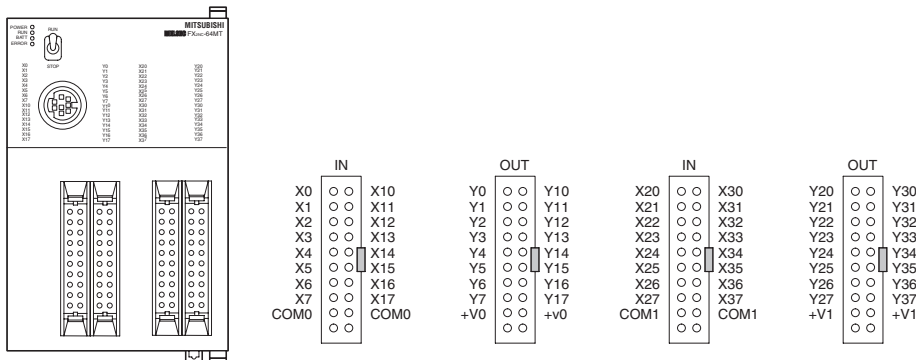

FX2NC-64MT-D/UL

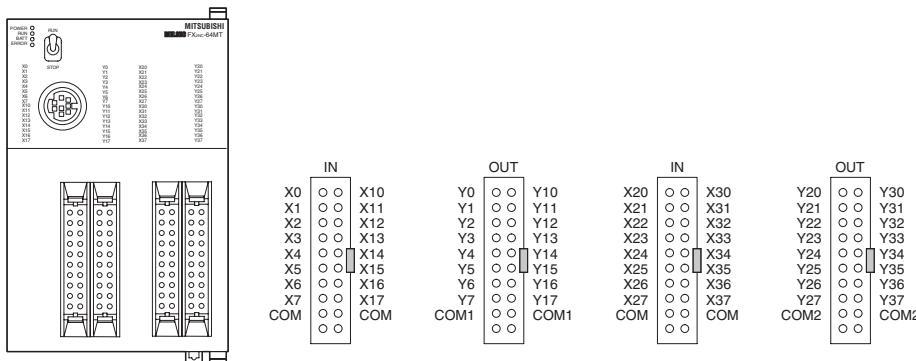

Base Units MELSEC FX2NC

FX2NC-96MT-D5S

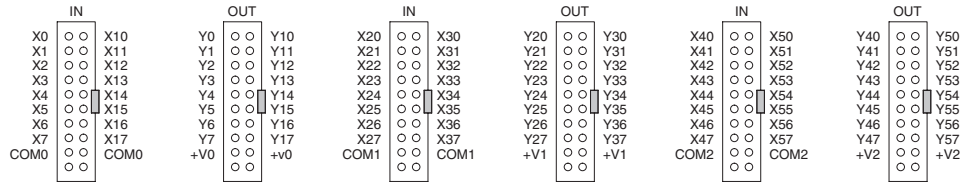
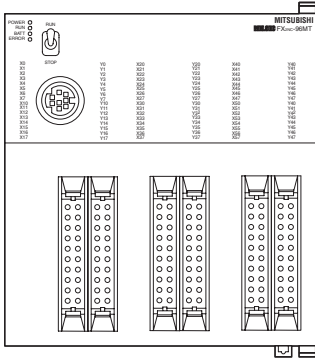

FX2NC-96MT-D/UL

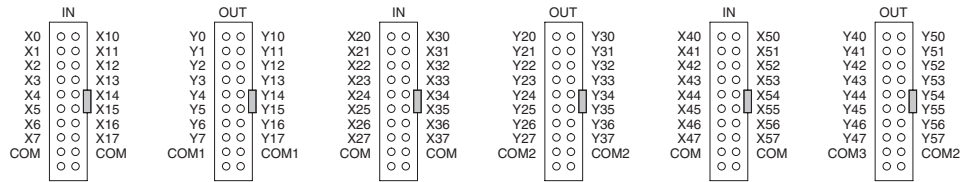
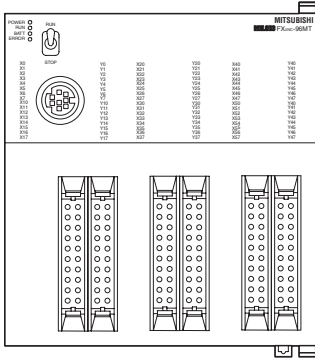

■ Base Units MELSEC FX3U

FX3u-32MR/ES

≡	S/S	0V	X0	X2	X4	X6	X10	X12	X14	X16	•
L	N	•	24V	X1	X3	X5	X7	X11	X13	X15	X17

FX3u-16MR/ES

≡	S/S	0V	X0	X2	X4	X6	•	•	•
L	N	•	24V	X1	X3	X5	X7	•	•

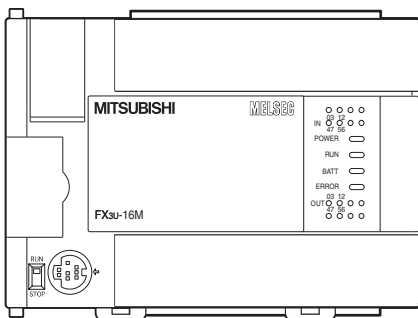

FX3u-16MR/ES

•	Y0	Y1	Y2	Y3	Y4	Y5	Y6	Y7	•
•	Y0	Y1	Y2	Y3	Y4	Y5	Y6	Y7	•

FX3u-32MR/ES

Y0	Y2	•	Y4	Y6	•	Y10	Y12	•	Y14	Y16	•
COM1	Y1	Y3	COM2	Y5	Y7	COM3	Y11	Y13	COM4	Y15	Y17

FX3u-80MR/ES

≡	S/S	0V	0V	X0	X2	X4	X6	X10	X12	X14	X16	•	X20	X22	X24	X26	•	X30	X32	X34	X36	•	X40	X42	X44	X46	•
L	N	•	24V	24V	X1	X3	X5	X7	X11	X13	X15	X17	•	X21	X23	X25	X27	•	X31	X33	X35	X37	•	X41	X43	X45	X47

FX3u-64MR/ES

≡	S/S	0V	0V	X0	X2	X4	X6	X10	X12	X14	X16	X20	X22	X24	X26	X30	X32	X34	X36	•
L	N	•	24V	24V	X1	X3	X5	X7	X11	X13	X15	X17	X21	X23	X25	X27	X31	X33	X35	X37

FX3u-48MR/ES

≡	S/S	0V	X0	X2	X4	X6	X10	X12	X14	X16	X20	X22	X24	X26	•
L	N	•	24V	X1	X3	X5	X7	X11	X13	X15	X17	X21	X23	X25	X27

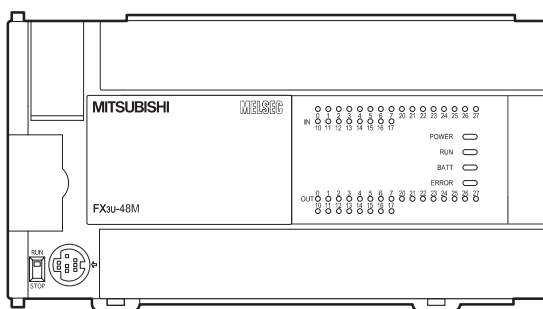

FX3u-48MR/ES

Y0	Y2	•	Y4	Y6	•	Y10	Y12	•	Y14	Y16	Y20	Y22	Y24	Y26	COM5
COM1	Y1	Y3	COM2	Y5	Y7	COM3	Y11	Y13	COM4	Y15	Y17	Y21	Y23	Y25	Y27

FX3u-64MR/ES

Y0	Y2	•	Y4	Y6	•	Y10	Y12	•	Y14	Y16	•	Y20	Y22	Y24	Y26	Y30	Y32	Y34	Y36	COM6
COM1	Y1	Y3	COM2	Y5	Y7	COM3	Y11	Y13	COM4	Y15	Y17	COM5	Y21	Y23	Y25	Y27	Y31	Y33	Y35	Y37

FX3u-80MR/ES

Y0	Y2	•	Y4	Y6	•	Y10	Y12	•	Y14	Y16	•	Y20	Y22	Y24	Y26	•	Y30	Y32	Y34	Y36	•	Y40	Y42	Y44	Y46	•	
COM1	Y1	Y3	COM2	Y5	Y7	COM3	Y11	Y13	COM4	Y15	Y17	COM5	Y21	Y23	Y25	Y27	•	COM6	Y31	Y33	Y35	Y37	COM7	Y41	Y43	Y45	Y47

■ Compact Extension Units MELSEC FXon

FX0N-40ET-DSS	⊕	S/S	S/S	X1	X3	X5	X7	X1	X3	X5	X7	X1	X3	X5	X7
	⊖	•	X0	X2	X4	X6	X0	X2	X4	X6	X0	X2	X4	X6	
FX0N-40ER-DS	⊕	S/S	S/S	X1	X3	X5	X7	X1	X3	X5	X7	X1	X3	X5	X7
	⊖	•	X0	X2	X4	X6	X0	X2	X4	X6	X0	X2	X4	X6	
FX0N-40ER-ES/UL	⊕	S/S	S/S	X1	X3	X5	X7	X1	X3	X5	X7	X1	X3	X5	X7
	L	N	•	X0	X2	X4	X6	X0	X2	X4	X6	X0	X2	X4	X6

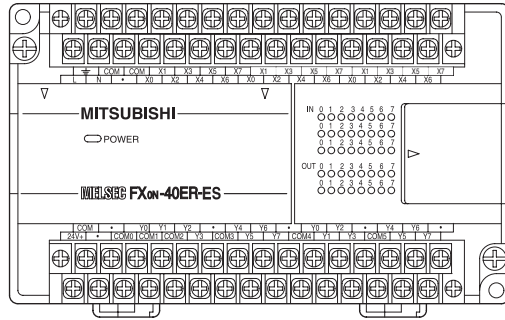

FX0N-40ER-ES/UL	0V	•	Y0	Y1	Y2	•	Y4	Y6	•	Y0	Y2	•	Y4	Y6	•
	24V	•	COM0	COM1	COM2	Y3	COM3	Y5	Y7	COM4	Y1	Y3	COM5	Y5	Y7
FX0N-40ER-DS	0V	•	Y0	Y1	Y2	•	Y4	Y6	•	Y0	Y2	•	Y4	Y6	•
	24V	•	COM0	COM1	COM2	Y3	COM3	Y5	Y7	COM4	Y1	Y3	COM5	Y5	Y7
FX0N-40ET-DSS	0V	•	Y0	Y1	Y2	•	Y4	Y6	•	Y0	Y2	•	Y4	Y6	•
	24V	•	+V0	+V1	+V2	Y3	+V3	Y5	Y7	+V4	Y1	Y3	+V5	Y5	Y7

■ Powered Compact Extension Units MELSEC FX2N

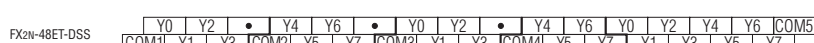
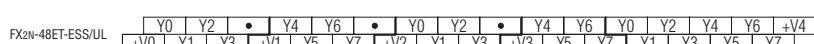
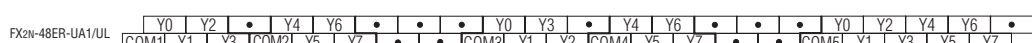
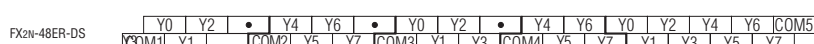
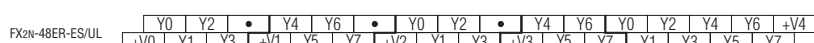
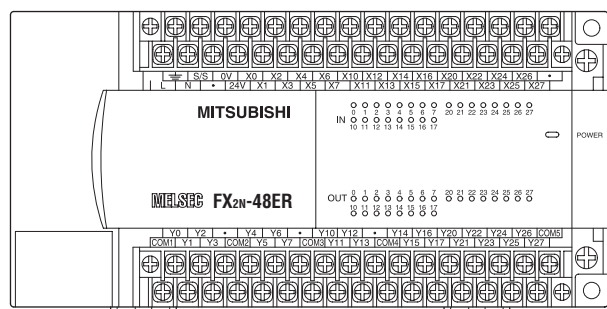
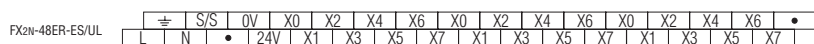
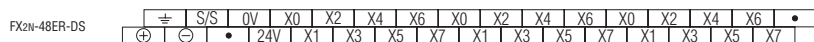
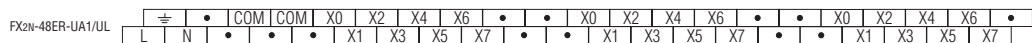
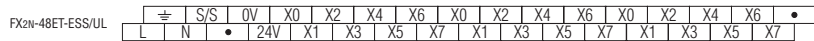
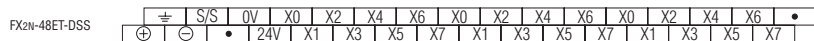
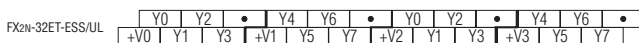
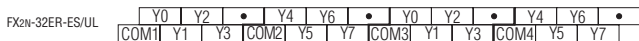
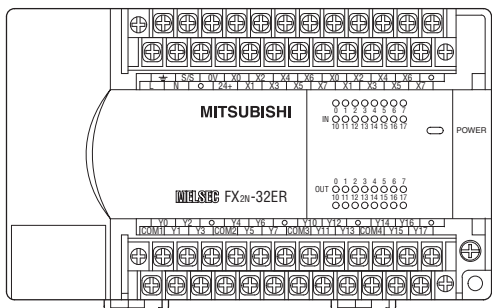
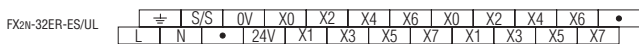
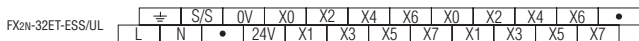

Modular Extension Units MELSEC FX2N

FX2N-16EX-ES/UL

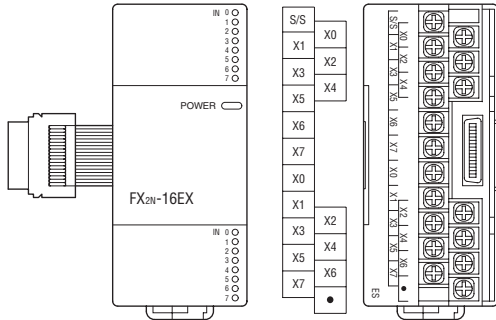

FX2N-8EYT-ESS/UL

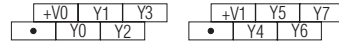

FX2N-8EYR-ES/UL

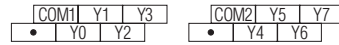

FX2N-8EX-ES/UL

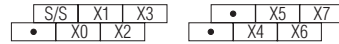

FX2N-8EX-UA1/UL



FX2N-8ER-ES/UL

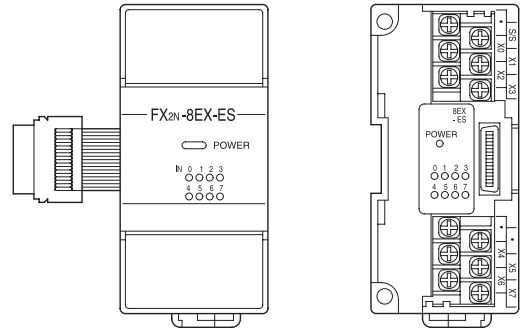
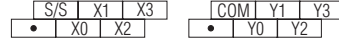

FX2N-16EYT-ESS/UL

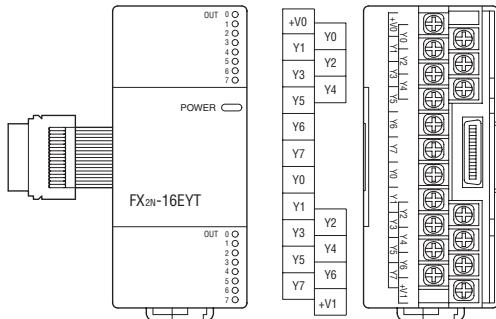

FX2N-16EYR-ES/UL

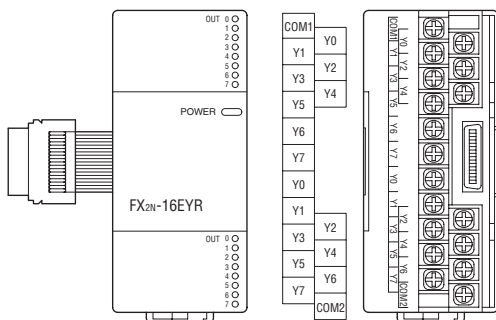

FX2N-16EYS-ES/UL

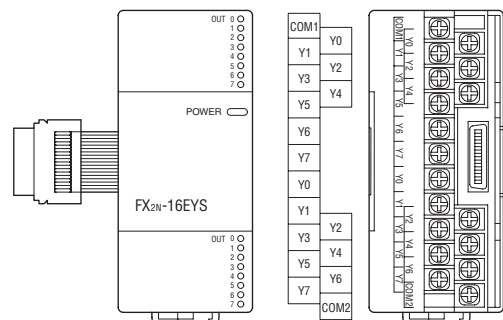

Extension Adapter Boards MELSEC FX1N

FX1N-4EX-BD

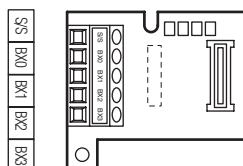

FX1N-2EYT-BD

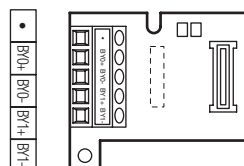

■ Extension Units MELSEC FX2NC

FX2NC-16EX-DS

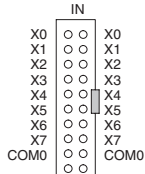
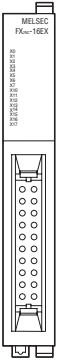

FX2NC-16EX-D/UL

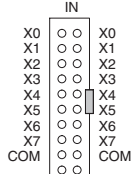
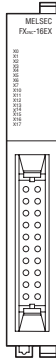

FX2NC-16EYT-DSS

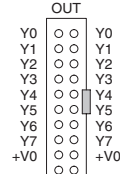
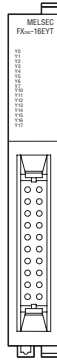

FX2NC-16EYT-D/UL

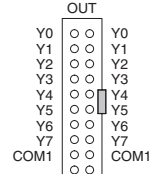
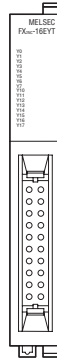

FX2NC-16EX-T-DS

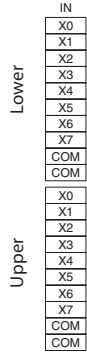
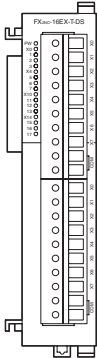

FX2NC-16EYR-T-DSS

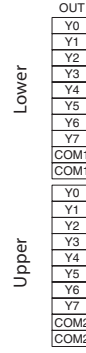
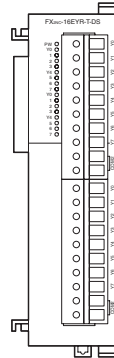

FX2NC-32EX-DS

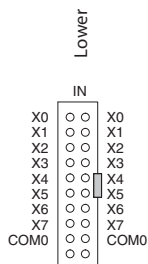
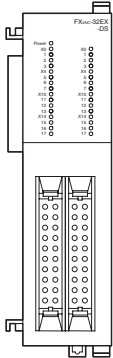

FX2NC-32EYT-DSS

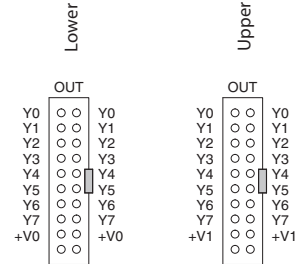
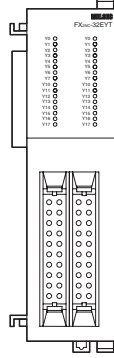

FX2NC-32EX-D/UL

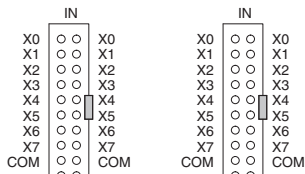
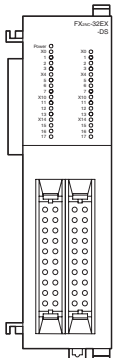

FX2NC-32EYT-D/UL

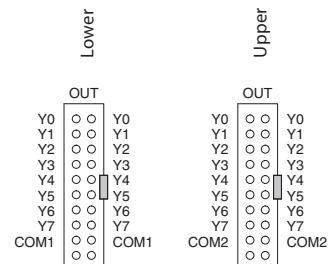
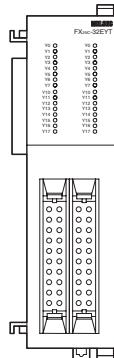

Special Function Modules MELSEC FX3U

FX3U-4HSX-ADP

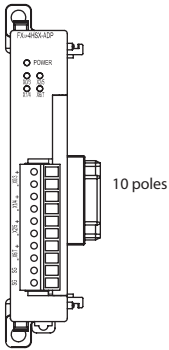

- X0/3+
- X0/3-
- X1/4+
- X1/4-
- X2/5+
- X2/5-
- X6/7+
- X6/7-
- SG
- SG

10 poles

FX3U-2HSY-ADP

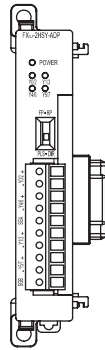

- Y0/2+
- Y0/2-
- Y4/6+
- Y4/6-
- SGA
- Y1/3+
- Y1/3-
- Y5/7+
- Y5/7-
- SGB

10 poles

FX2NC-4DA

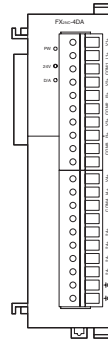

- V1+
- I1+
- COM1
- SLD
- V2+
- I2+
- COM2
- SLD
-
-
- V3+
- I3+
- COM3
- SLD
- V4+
- I4+
- COM4
- SLD
- ⏏
- ⏏

FX2NC-4AD

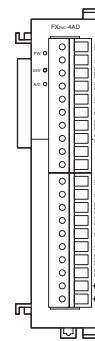

FX3U-4AD-ADP

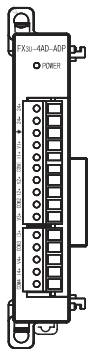

- 24+
- 24-
- ⏏
- V1+
- I1+
- COM1
- V2+
- I2+
- COM2
- V3+
-
-
-
-
-
- I3+
- COM3
- V4+
- I4+
- COM4

10 poles

5 poles

FX3U-4DA-ADP

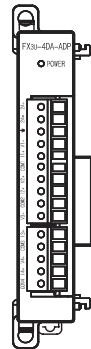

- 24+
- 24-
- ⏏
- V1+
- I1+
- COM1
- V2+
- I2+
- COM2
- V3+
-
-
-
-
-
- I3+
- COM3
- V4+
- I4+
- COM4

10 poles

5 poles

FX3U-4AD-PT-ADP

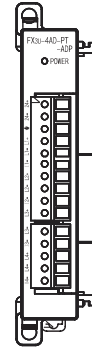

- 24+
- 24-
- ⏏
- L1+
- L1-
- I1-
- L2+
- L2-
- L3+
-
-
-
-
-
- L3-
- I3-
- L4+
- L4-
- I4-

10 poles

5 poles

FX3U-4AD-TC-ADP

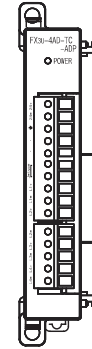

- 24+
- 24-
- ⏏
-
-
- J-type
- J-type
- L1+
- L1-
- L2+
-
-
-
-
-
- L2-
- L3-
- L4+
- L4-
- I4-

10 poles

5 poles

FX3U-232-ADP

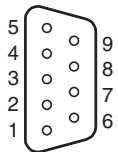
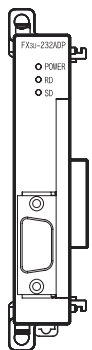

- 1 CD(DCD)
- 2 RD(RXD)
- 3 SD(TXD)
- 4 ER(DTR)
- 5 SG(GND)
- 6 DR(DSR)
- 7 •
- 8 •
- 9 •

FX3U-485-ADP



- RDA
- RDB
- SDA
- SDB
- SG

5 poles

Terminal resistance setting switch

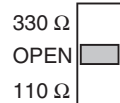

■ Communications Boards MELSEC FX3U

FX3U-USB-BD

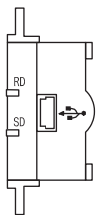

FX3U-232-BD

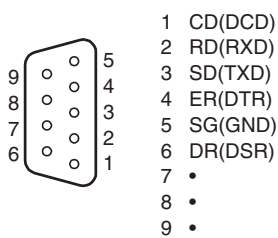
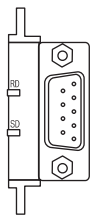

FX3U-422-BD

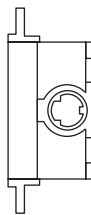

FX3U-485-BD

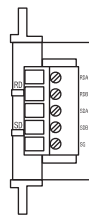

5 poles

RDA
RDB
SDA
SDB
SG

Terminal resistance setting switch

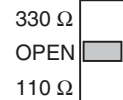

■ High Speed Counter and Positioning Modules MELSEC FX0N / FX1N / FX2N

FX2N-1PG-E

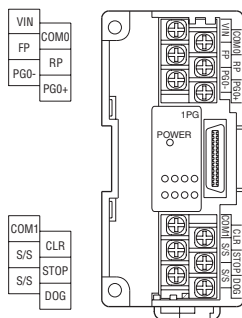
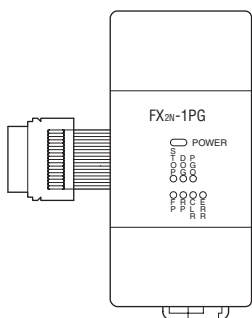

FX2N-10PG

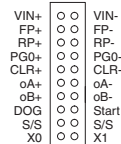
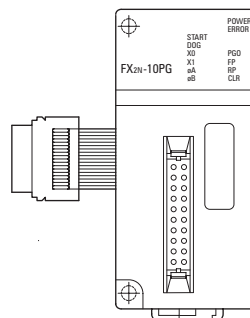

FX2N-2LC

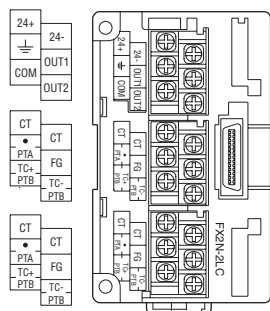
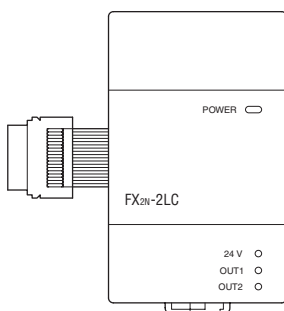

FX2N-1HC

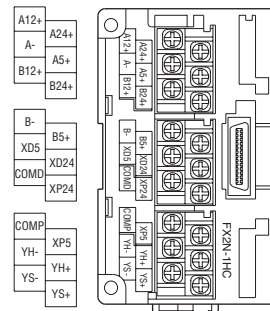
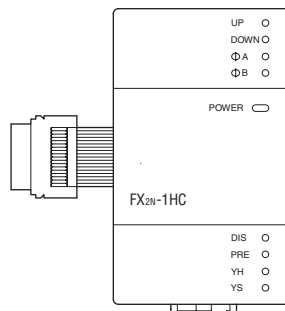

■ Analog Modules MELSEC FX2N

FX2N-2AD

V IN2	I IN2	COM2
V IN1	I IN1	COM1

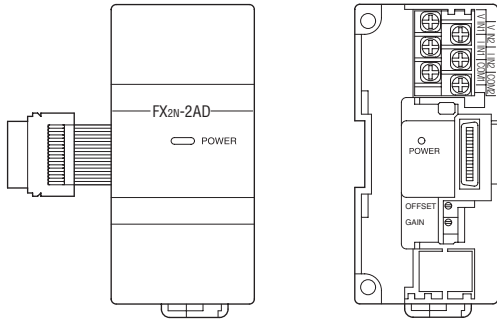

FX2N-2DA

VOUT2	IOUT2	COM2
VOUT1	IOUT1	COM1

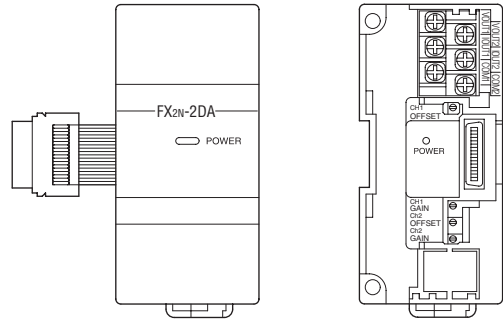

FX2N-4AD

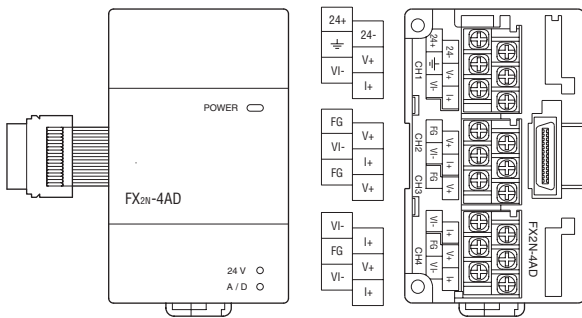

FX2N-4DA

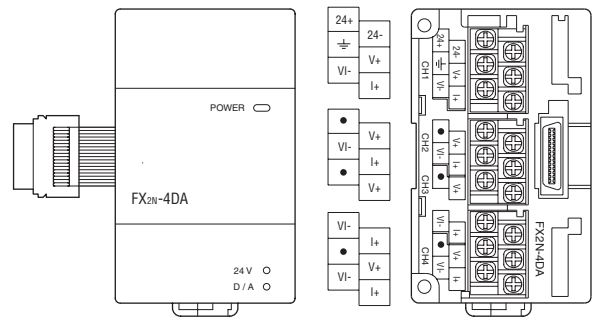

FX2N-4AD-TC

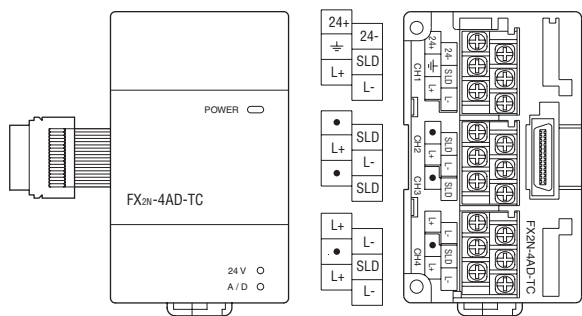

FX2N-4AD-PT

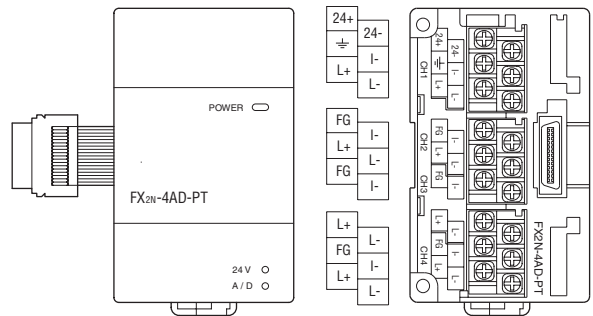

6
TERMINALS & DIMENSIONS

■ Analog Modules MELSEC FX0N / FX2N

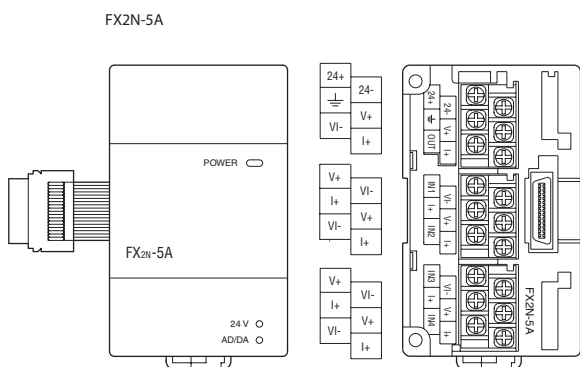
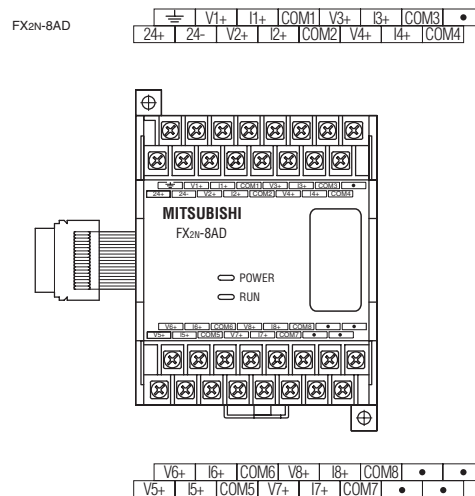
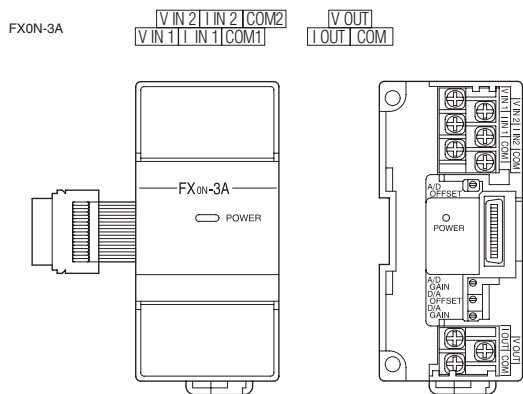

■ Analog Adapter Boards MELSEC FX1N

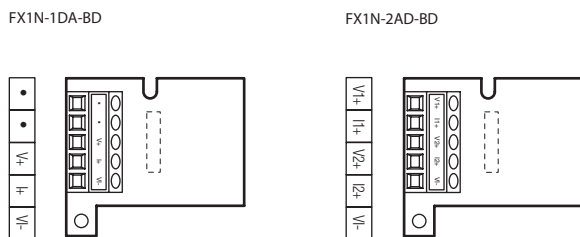

Network Modules MELSEC FX2N

FX0N-32NT-DP

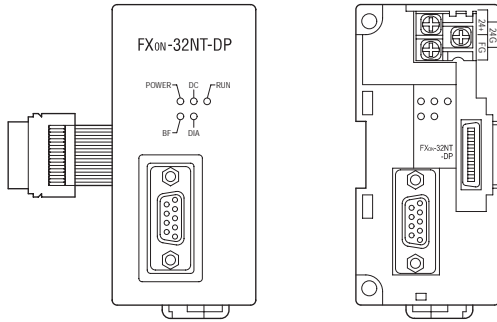

FX2N-32CCL

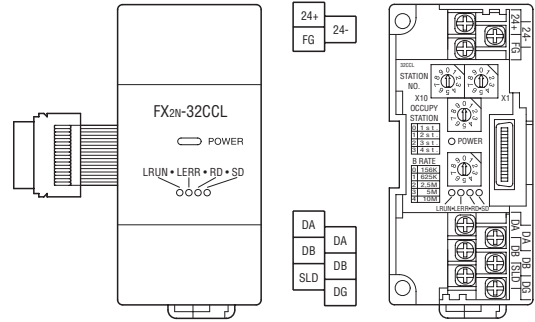

FX2N-32DP-IF

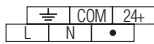

FX2N-32DP-IF-D

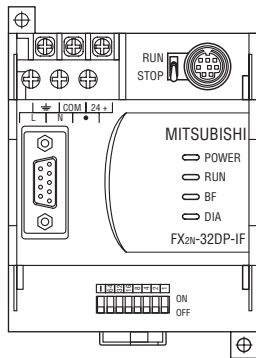
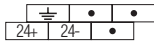

FX2N-16CCL-M

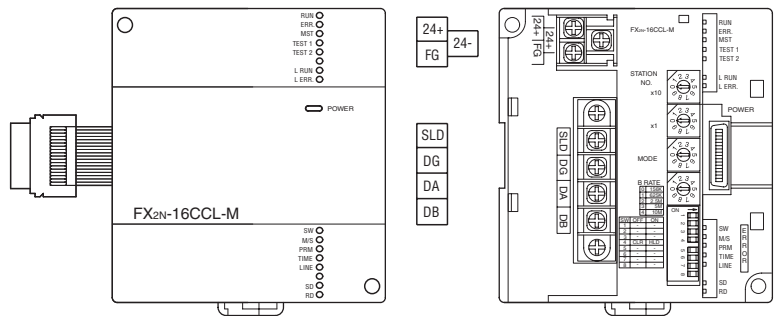

FX2N-32ASI-M

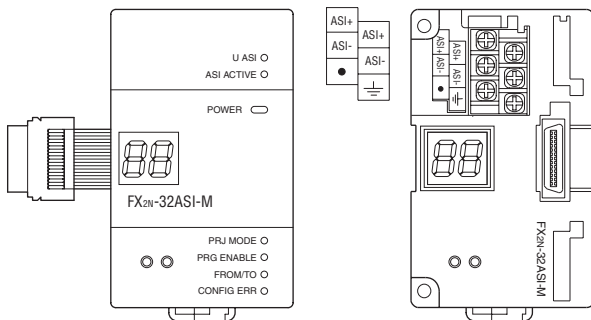

FX2N-32CAN

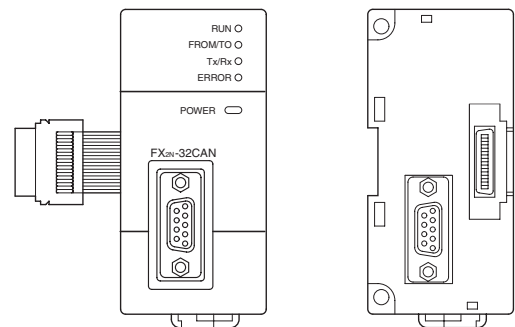

■ Network Modules MELSEC FX2N

FX2N-64DNET

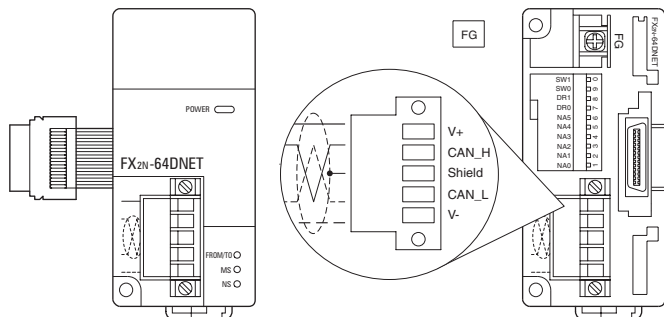

■ Communications Module MELSEC FX2N

FX2N-232IF

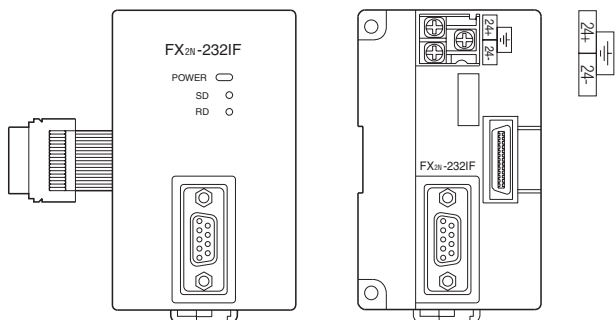

■ Interface Module MELSEC FX2NC

FX2NC-232ADP

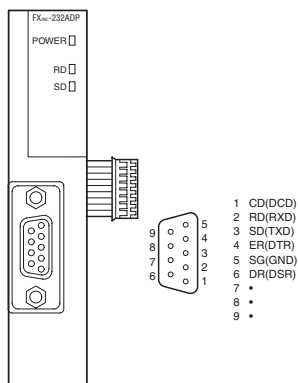

- 1 CD(DCD)
- 2 RD(RXD)
- 3 SD(TXD)
- 4 ER(DTR)
- 5 SG(GND)
- 6 DR(DSR)
- 7 •
- 8 •
- 9 •

FX2NC-485ADP

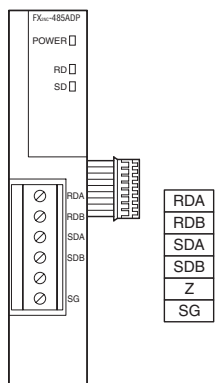

- RDA
- RDB
- SDA
- SDB
- Z
- SG

Dimensions for Terminal Blocks

TB-8EX-S

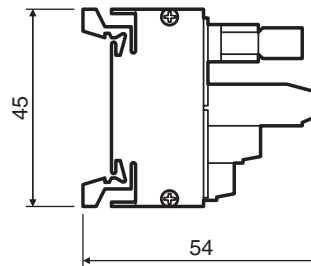
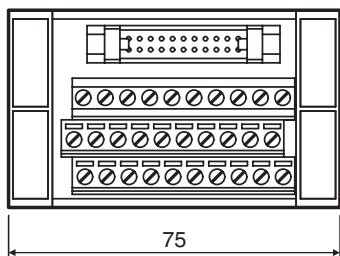

TB-8EX-C

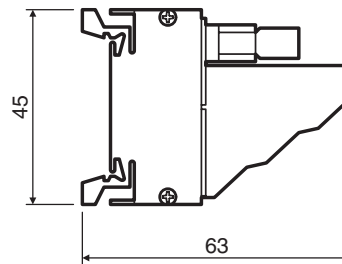
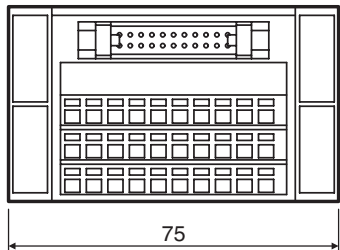

TB-16EX-S

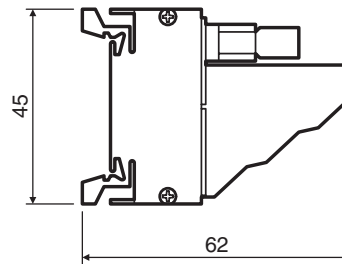
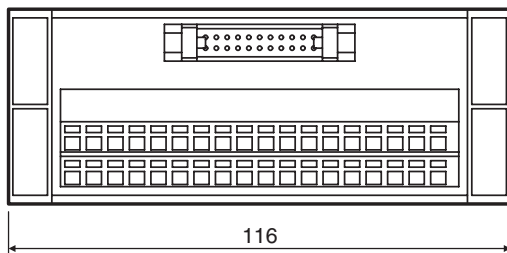

TB-16EX-C

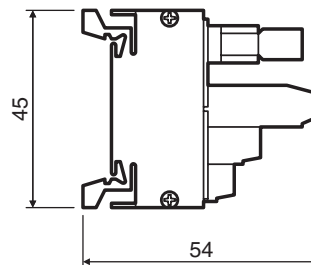
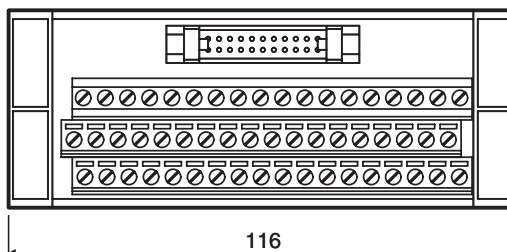

TB-20-S

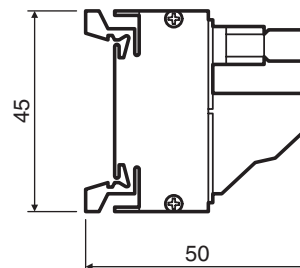
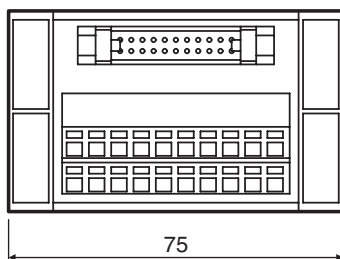

TB-20-C

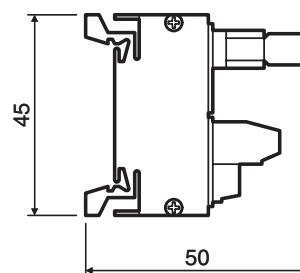
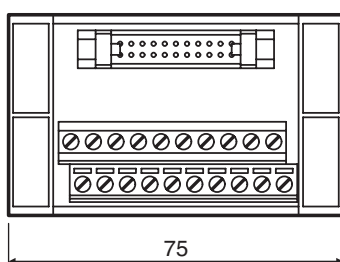

Dimensions of the ALPHA series

AL2-14M□-□, AL2-24M□-□

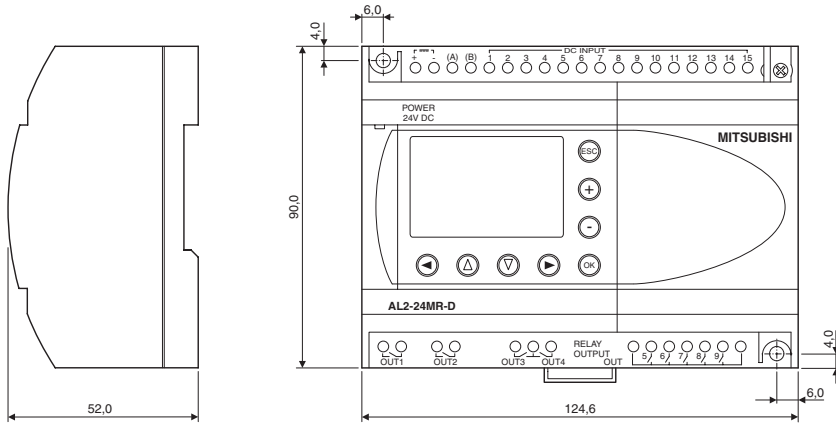

AL2-4EY□, AL2-2DA

AL2-ASI-BD

AL2-2PT-ADP, AL2-2TC-ADP

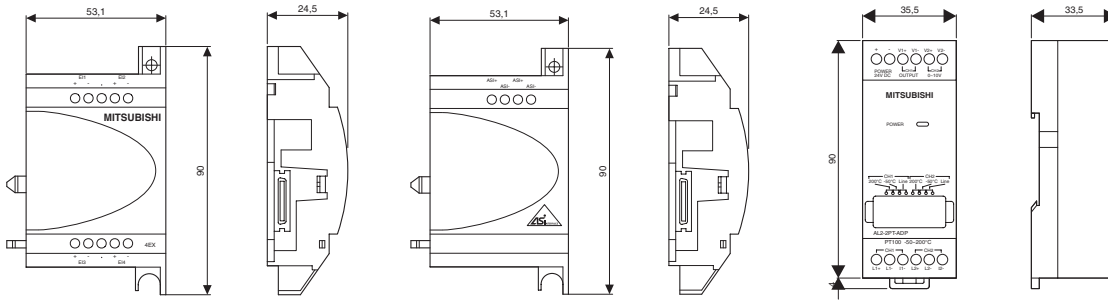

Mounting frame AL-FRAME

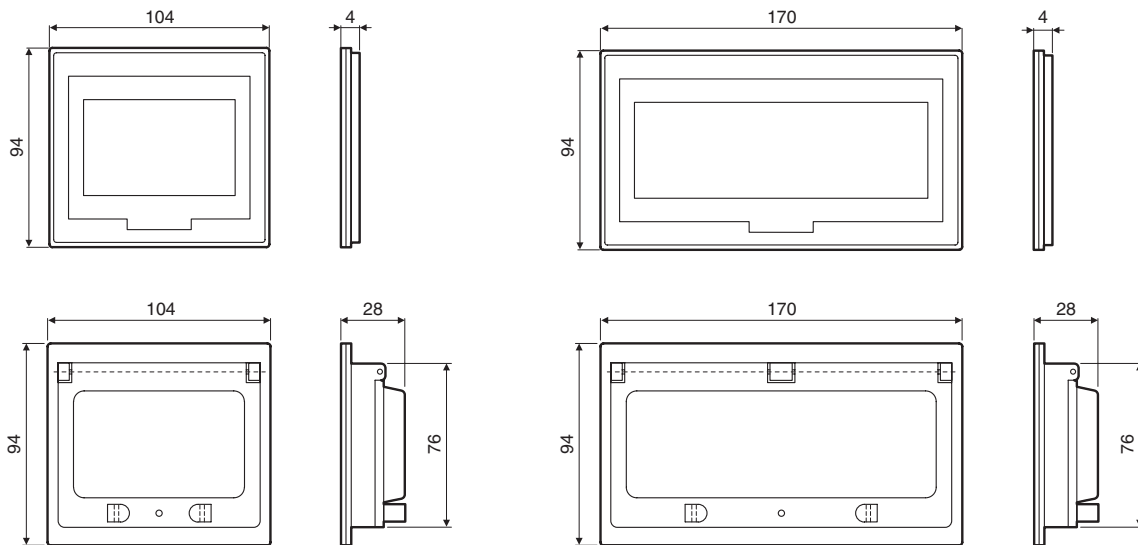

All dimensions in mm

Dimensions of Base Units FX1S

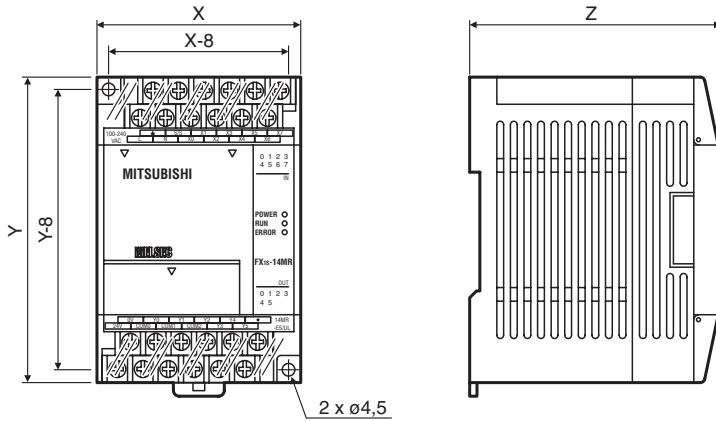

Base unit	X	Y	Z
FX1S-10MR-DS	60	90	49
FX1S-10MR-ES/UL	60	90	75
FX1S-10MT-DSS	60	90	49
FX1S-14MR-DS	60	90	49
FX1S-14MR-ES/UL	60	90	75
FX1S-14MT-DSS	60	90	49
FX1S-20MR-DS	75	90	49
FX1S-20MR-ES/UL	75	90	75
FX1S-20MT-DSS	75	90	49
FX1S-30MR-DS	100	90	49
FX1S-30MR-ES/UL	100	90	75
FX1S-30MT-DSS	100	90	49

Dimensions of Base Units FX1N

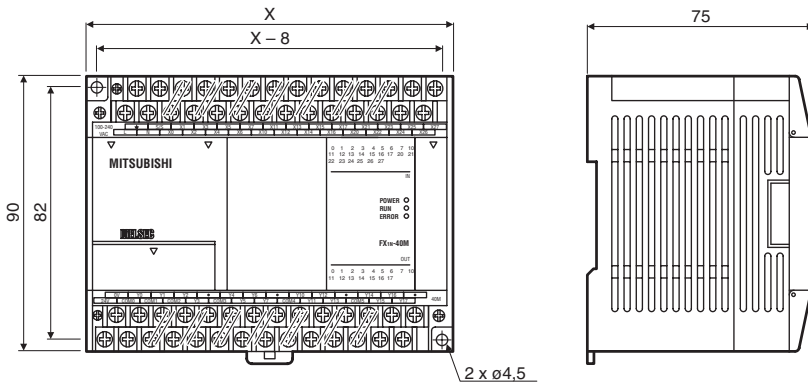

Type	X (in mm)
FX1N-14MR□□□	90
FX1N-14MT□□□	90
FX1N-24MR□□□	90
FX1N-24MT□□□	90
FX1N-40MR□□□	130
FX1N-40MT□□□	130
FX1N-60MR□□□	175
FX1N-60MT□□□	175

Dimensions of Base Units MELSEC FX2N

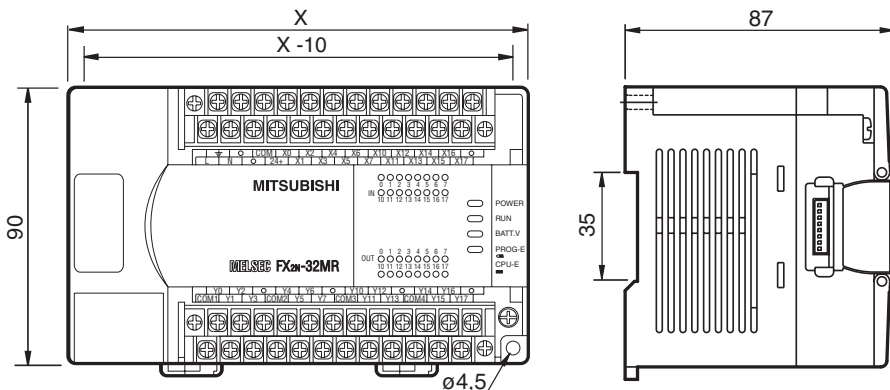

Base Units

Type	X (in mm)
FX2N-16M□□□	130
FX2N-32M□□□	150
FX2N-48M□□□	182
FX2N-64M□□□	220
FX2N-80M□□□	285
FX2N-128M□□□	350

Dimensions of Compact Extension Units FX0N

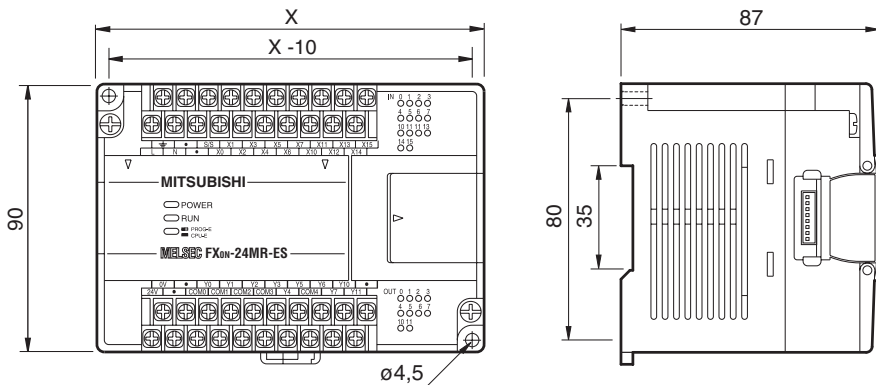

Type	X (in mm)
FX0N-40ER-DS	150
FX0N-40ER-ES/UL	150
FX0N-40ET-DSS	150

Dimensions of Compact Extension Units and Modular Extension Blocks MELSEC FX2N

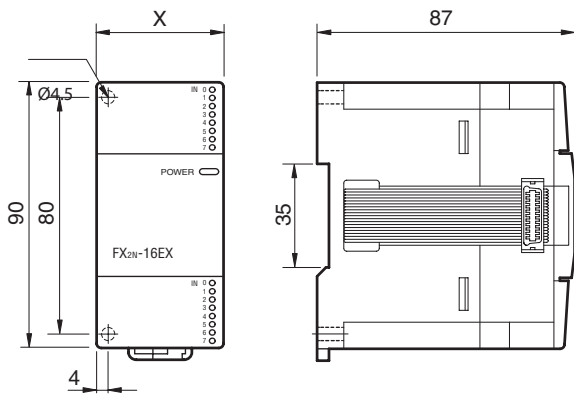

Compact Extension Units

Type	X (in mm)
FX2N-32E□□□	150
FX2N-48E□□□	182
FX2N-48ER-UA1/UL	220

Modular Extension Blocks

Type	X (in mm)
FX2N-8E□□□	43
FX2N-16E□□□	40

Dimensions of Extension Adapter Boards FX1N

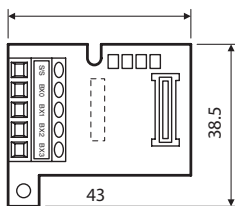

Dimensions of Base Units FX2NC

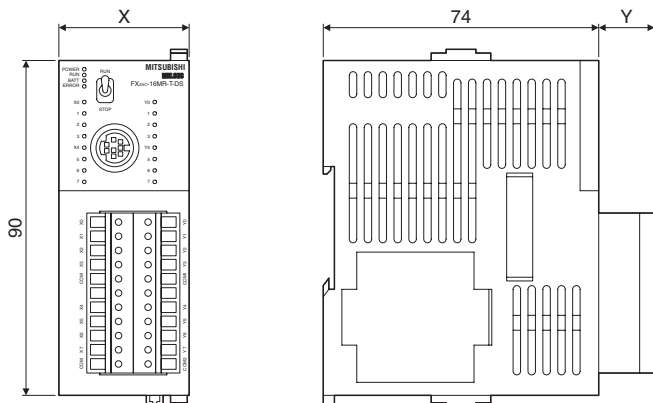

Base Units

Type	X	Y
FX2NC-16MT-DSS	35	13
FX2NC-32MT-DSS	35	13
FX2NC-64MT-DSS	60	13
FX2NC-96MT-DSS	86	13

Type	X	Y
FX2NC-16MR-T-DS*	35	15

* with connector like Extension units

All dimensions in mm

Dimensions of Modular Extension Units FX2NC

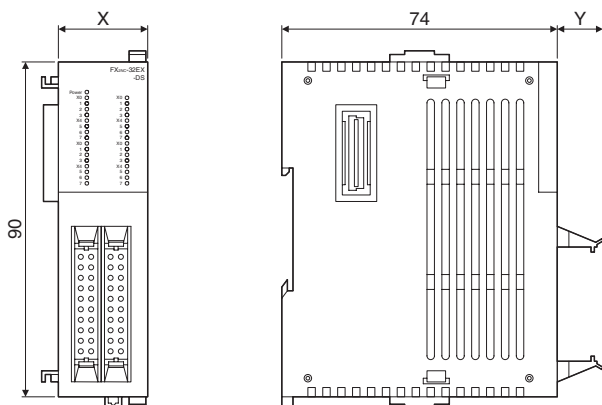

Extension Units

Type	X	Y
FX2NC-16EX-DS	14.6	13
FX2NC-16EYT-DSS	14.6	13
FX2NC-16EX-D/UL	14.6	13
FX2NC-16EYT-D/UL	14.6	13
FX2NC-32EX-DS	26.2	13
FX2NC-32EYT-DSS	26.2	13
FX2NC-32EX-D/UL	26.2	13
FX2NC-32EYT-D/UL	26.2	13

Type	X	Y
FX2NC-16EX-T-DS*	20.2	15
FX2NC-16EYR-T-DSS*	24.2	15

* with connector like base units

All dimensions in mm

Dimensions of Special Function Modules FX2NC

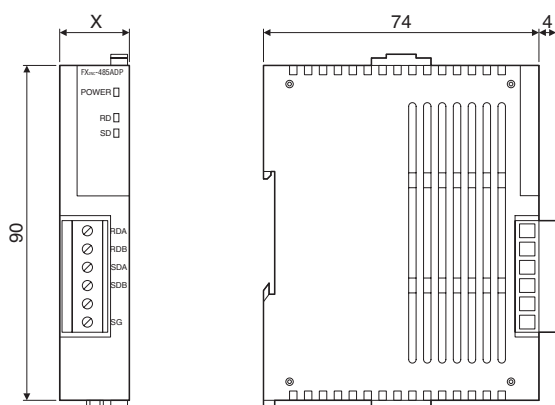

Special Function Modules

Type	X
FX2NC-4AD	20.2
FX2NC-4DA	24.2
FX2NC-232ADP	19.1
FX2NC-485ADP	19.1
FX2NC-CNV-IF	14.6
COM-ET-10-T	16.1

All dimensions in mm

Dimensions of Base Units FX3U

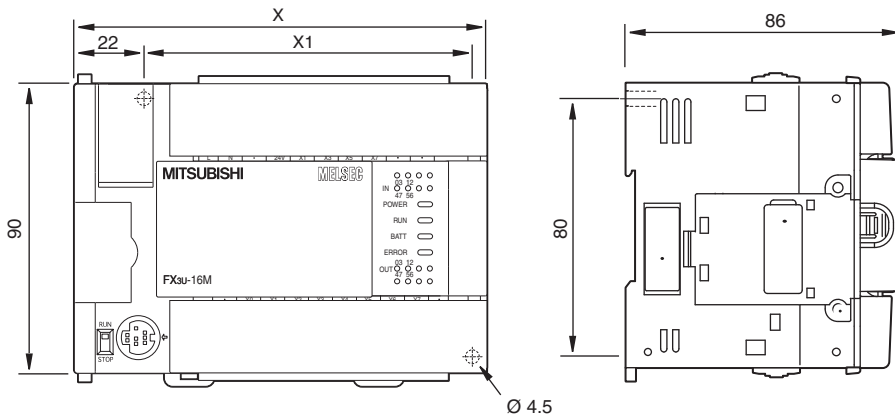

Base Units

Type	X (in mm)	X1 (in mm)
FX3U-16M□□□	130	103
FX3U-32M□□□	150	123
FX3U-48M□□□	182	155
FX3U-64M□□□	220	193
FX3U-80M□□□	285	258

All dimensions in mm

Dimensions of Special Function Modules FX3U

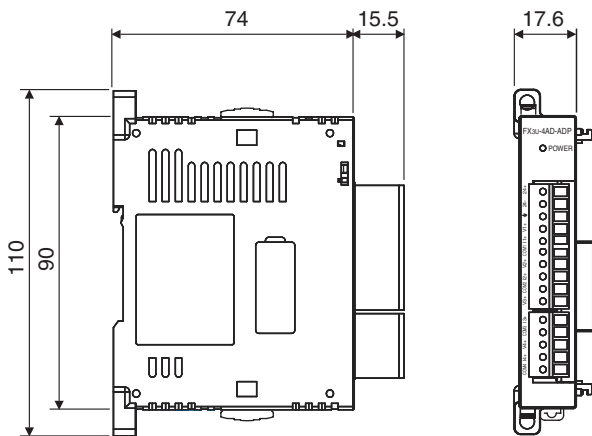

All dimensions in mm

Dimensions of Expansion Boards FX3U

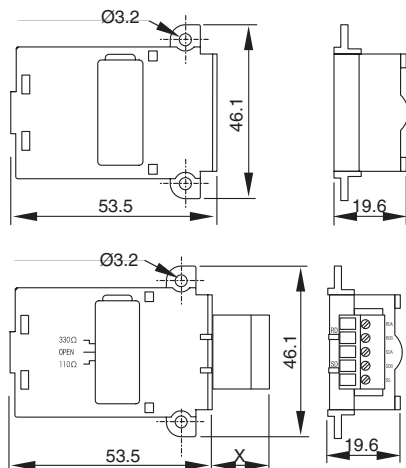

Expansion Boards

Type	X (in mm)
FX3U-CNV	—
FX3U-USB	—
FX3U-485	15.5
FX3U-422	—
FX3U-232	9.2

All dimensions in mm

Dimensions of Special Function Modules MELSEC FX2N

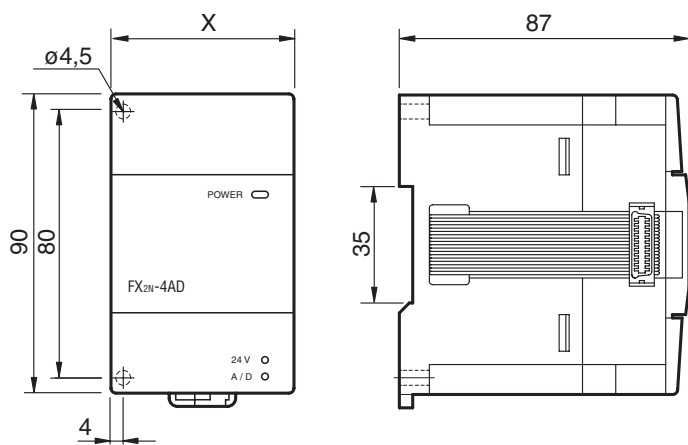

Special Function Modules FX0N/FX2N

Type	X (in mm)
FX0N-3A	43
FX2N-2DA	43
FX2N-2AD	43
FX2N-4DA	55
FX2N-4AD	55
FX2N-4AD-TC	55
FX2N-4AD-PT	55
FX2N-1HC	55
FX2N-1PG-E	43
FX2N-10PG	43
FX2N-2LC	55
FX2N-5A	55
FX2N-232-IF	55
FX2N-32ASI-M	55
FX2N-32CCL	43
FX2N-32CAN	43
FX2N-64DNET	43

FX2N-8AD

FX2N-32DP-IF

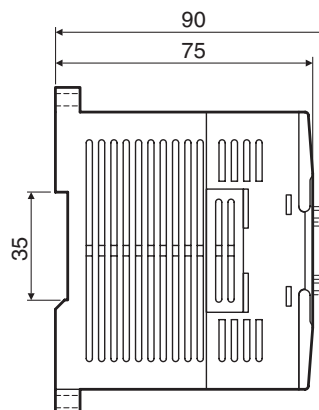
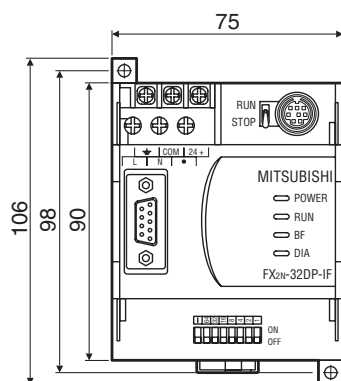
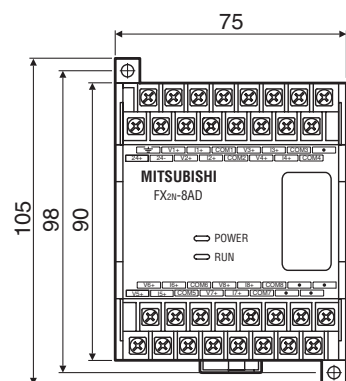

Dimensions for Accessories

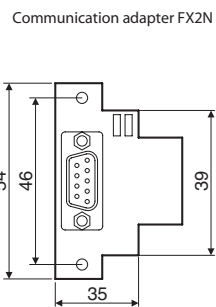
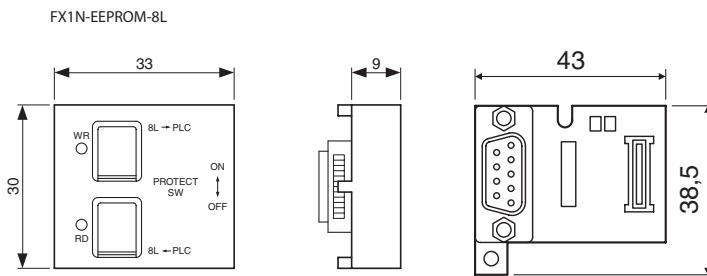
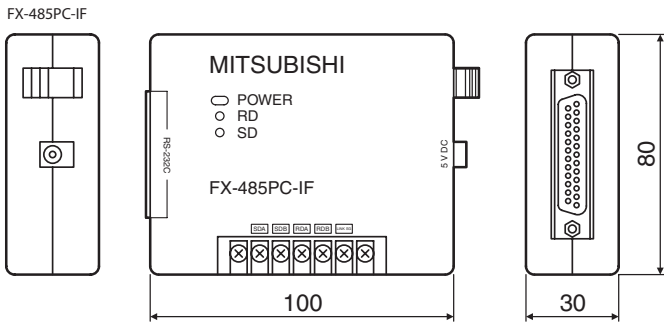

Dimensions for Display Panels

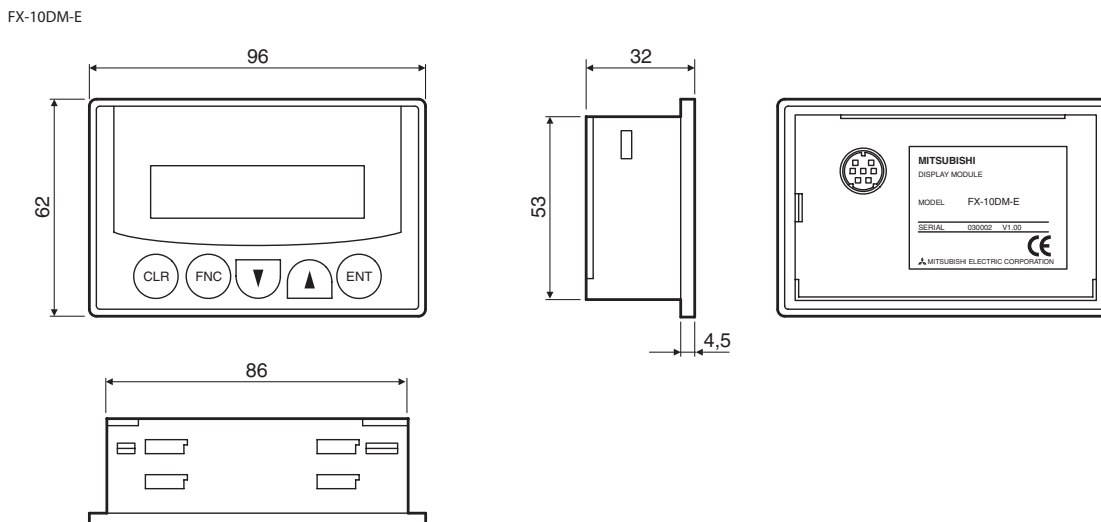
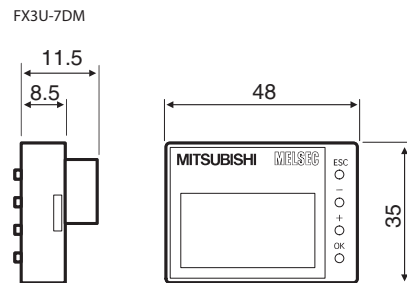
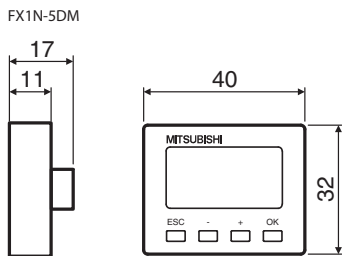

MELSOFT – Programming and Documentation Software for Standard Personal Computers



With the MELSOFT software family Mitsubishi Electric offers efficient software packages helping to reduce programming and setup times to a high degree. The MELSOFT software family provides instant access, direct communications, compatibility, and open exchange of variables.

The MELSOFT family comprises:

- Programming packages AL-PCS/WIN and GX Developer
- Various development software for operator terminals (please refer to the GOT Technical Catalogue)
- Software for a dynamic data exchange like MX Change

AL-PCS/WIN is recommended as a cost-effective beginners package for the ALPHA series. This package offers a quick and easy introduction to programming.

GX Developer is the right decision for a universal programming package. In addition, GX Developer is fully compatible with all MELSEC PLCs, including A and Q series controllers.

For detailed information please order our separate MELSOFT brochure.

ALPHA Programming Software

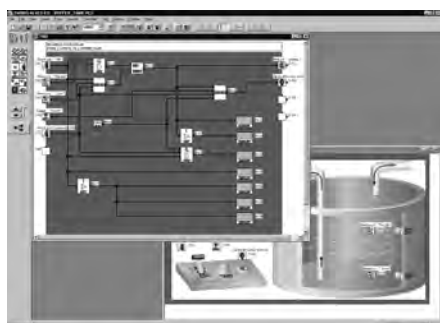

AL-PCS/WIN Programming Software

All controllers of the ALPHA series can be programmed with the MS Windows software AL-PCS/WIN. Programming the ALPHA with this software is very easy and is done by placing the different program elements on a graphical programming environment. The connections (wiring) between the inputs, function blocks, and outputs are drawn graphically by mouse click to build the logic. By this, programs with up to 200 function blocks can be created, where each single function in a program can be used as many times as desired. A complete documentation of the program can be created directly from AL-PCS/WIN.

Software	AL-PCS/WIN	
Series	Alpha series	
Language	7 languages (English/German/French/Italian/Spanish/Swedish/Russian)	
Applicable for	Windows 95/98/ME/NT/2000/XP	
Order information	Art. no.	152603

PLC Training Software

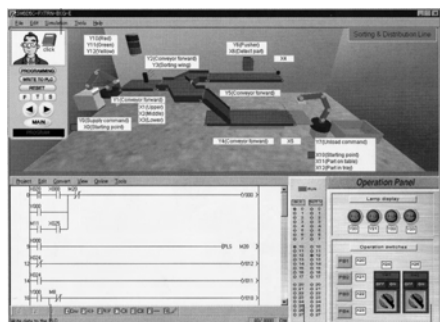

FX-TRN-BEG-E Training Software

The FX-TRN-BEG-E training software package is designed to help beginners get started with the programming of PLC systems. It combines a simulated PLC environment with expert tutorials. A real-time module simulates the operation of the PLC program. Simulation speed is adjustable and you can also access system elements and display program status while the process is running.

Software	FX-TRN-BEG-E	
Series	Whole FX family	
Language	English	
Applicable for	Windows 95/98/ME/NT/2000/XP	
Order information	Art. no.	149714

7

SOFTWARE & PROGRAMMING

PLC Programming Software

■ GX Developer

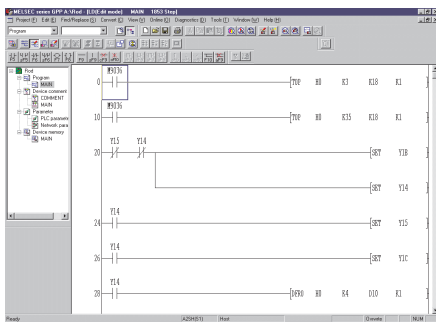

GX Developer is the standard programming software for all MELSEC PLC series and combines all functions of MELSEC MEDOC with the user guidance of Microsoft Windows.

With this software you can comfortably create PLC programs alternatively in the form of Ladder Diagrams or Instruction Lists. Both forms of representation can be toggled easily during operation.

Besides efficient monitoring and diagnostics functions GX Developer features an offline simulation of any PLC type.

With GX Developer all MELSEC PLCs from the FX1s to the Q25PH (Q series) are supported.

The GX Developer FX is limited to the programming of the FX series.

This software provides all the Windows-specific advantages and is especially suited to all MELSEC PLCs.

The software is supplied without an SC-09 programming cable, which can be ordered separately. This cable is needed for the connection between the PLC and a serial interface of a personal computer.

GX Developer can be run under MS Windows® 95/98/2000 and NT4.

Software	GX Developer FX V0800-1LOC-G	GX Developer FX V0800-1LOC-E	GX Developer V0800-1LOC-G	GX Developer V0800-1LOC-E
Series	FX1s, FX1N, FX2N, FX2NC	FX1s, FX1N, FX2N, FX2NC	All MELSEC PLCs	All MELSEC PLCs
Language	German	English	German	English
Disk type	CD ROM	CD ROM	CD ROM	CD ROM
Order information	Art. no. 152848	152863	152816	150420
Accessory	Programming cable SC-09, art. no.: 43393			

■ GX IEC Developer

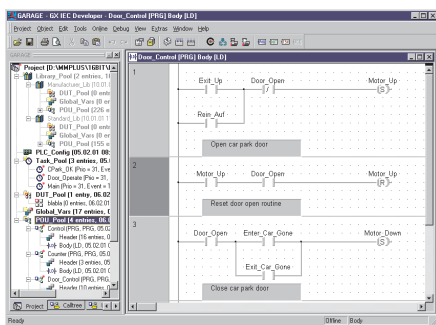

GX IEC Developer provides all functions of the pre-mentioned programs and in addition meets the programming standard: IEC 1131.3 (EN 61131). This makes the software ready for the programming standard of the future and offers beside the FX version in addition the full version as a basis for the on-leading programming of the MELSEC AnS/QnAS series, the MELSEC AnU/QnA series and MELSEC System Q.

GX IEC Developer can be run under Windows 95/98 and Windows NT/2000/XP.

The software is supplied without an SC-09 programming cable, which can be ordered separately. This cable is needed for the connection between the PLC and a serial interface of a personal computer.

Software	GX IEC Developer FX V0600-1LOC-G	GX IEC Developer FX V0600-1LOC-E	GX IEC Developer V0600-1LOC-G	GX IEC Developer V0600-1LOC-E
Series	FX1s, FX1N, FX2N, FX2NC	FX1s, FX1N, FX2N, FX2NC	All MELSEC PLCs	All MELSEC PLCs
Language	German	English	German	English
Disk type	CD ROM	CD ROM	CD ROM	CD ROM
Order information	Art. no. 152551	152562	152483	152536
Accessory	Programming cable SC-09, art. no.: 43393			

Profibus Networks Software

GX Configurator DP

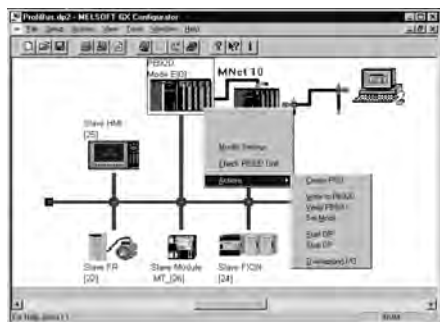

The GX Configurator DP is a user friendly configurations software for the open network PROFIBUS/DP.

The software package is a 32 bit application and runs under Windows 95/98 and Windows NT4/2000. Configuration of all PROFIBUS/DP modules for the MELSEC Ans/QnAS and A/Q series and also the FX family is possible.

Due to the supported extended user parameters of a GSD file, easy parameter setting of PROFIBUS/DP slave devices is possible even for third-party devices.

The new GX Configurator DP enables the download of all configuration data via an over-riding network.

All PROFIBUS modules are configured via the backside bus.

Software		GX Configurator DP V0500-110C-E
Supported PROFIBUS/DP master modules for the Mitsubishi MELSEC series		A1SJ71PB92D, AJ71PB92D, QJ71PB92D
Language		English / German
Disk type		CD ROM
Order information		
	Art. no.	145312
Accessory		
		Programming cable SC-09, art. no.: 43393

■ Hand-Held Programming Unit

Hand-Held Programming Unit FX-20 P-E-SET0



This small hand-held programming unit designed for industry has a user-friendly keyboard and a clearly laid out, back-lit LC display. On this programming unit, the MELSEC FX family PLCs can be programmed via Instruction List programming.

The FX-20 P-E-SET0 has an integrated CMOS-RAM with capacitor buffering. This ensures storage of the PLC program and its duplication, for example for series machines.

Specifications	FX-20 P-E-SET0	
Applicable for	Base units FX1S, FX1N, FX2N, FX2NC	
Ambient temperature	0 – 40 °C	
Ambient relative humidity (non-condensing)	35 – 85 %	
Power supply	DC 5 ±5 % via PLC	
Current consumption	mA	150
Display	LCD (with backlight)	
Character display	16 x 4	
Keyboard	35	
Memory	8,000 steps PLC-program	
Data security	Data is safed up to 3 days by capacitor.	
Cable	FX-20P-CAB0	
Weight	kg	0.4
Dimensions (W x H x D)	mm	90 x 170 x 30
Order information	Art. no.	149109

■ Programming Cable SC-09

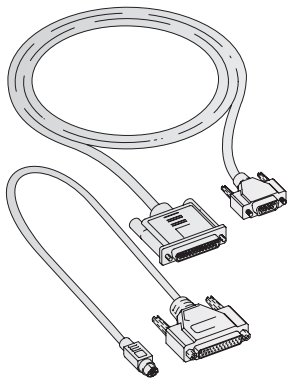

The SC-09 programming cable is used for the connection between the PLC and a serial interface of a personal computer.

The cable is divided into 2 parts and thus universally applicable for all Mitsubishi PLCs.

SC-09		
Order information	Art. no.	43393

Module type	CE		uL cUL	Ship approvals					
	EMC	LVD		ABS	DNV	LR	GL	BV	RINA
ALPHA 2 Base Units									
AL2-10MR-A	●	●	●	—	—	—	—	—	—
AL2-10MR-D	●	●	●	—	—	—	—	—	—
AL2-14MR-A	●	●	●	—	●	—	—	—	—
AL2-14MR-D	●	●	●	—	●	—	—	—	—
AL2-24MR-A	●	●	●	—	●	—	—	—	—
AL2-24MR-D	●	●	●	—	●	—	—	—	—
ALPHA Extension Modules									
AL2-4EX-A2	●	●	●	—	●	—	—	—	—
AL2-4EX	●	●	●	—	●	—	—	—	—
AL2-4EYR	●	●	●	—	●	—	—	—	—
AL2-4EYT	●	●	●	—	●	—	—	—	—
AL2-2DA	●	●	●	—	—	—	—	—	—
AL2-2PT-ADP	●	●	●	—	—	—	—	—	—
AL2-2TC-ADP	●	●	●	—	—	—	—	—	—
AL2-ASI-BD	●	●	●	—	●	—	—	—	—
FX1S Base Units									
FX1S-10MR-DS	●	●	●	●	—	●	●	—	●
FX1S-10MR-ES/UL	●	●	●	●	—	●	●	—	●
FX1S-10MT-DSS	●	○	●	●	—	●	●	—	●
FX1S-14MR-DS	●	●	●	●	—	●	●	—	●
FX1S-14MR-ES/UL	●	●	●	●	—	●	●	—	●
FX1S-14MT-DSS	●	○	●	●	—	●	●	—	●
FX1S-20MR-DS	●	●	●	●	—	●	●	—	●
FX1S-20MR-ES/UL	●	●	●	●	—	●	●	—	●
FX1S-20MT-DSS	●	○	●	●	—	●	●	—	●
FX1S-30MR-DS	●	●	●	●	—	●	●	—	●
FX1S-30MR-ES/UL	●	●	●	●	—	●	●	—	●
FX1S-30MT-DSS	●	○	●	●	—	●	●	—	●
FX1N Base Units									
FX1N-14MR-DS	●	●	●	●	—	●	●	—	●
FX1N-14MR-ES/UL	●	●	●	●	—	●	●	—	●
FX1N-14MT-DSS	●	○	●	●	—	●	●	—	●
FX1N-24MR-DS	●	●	●	●	—	●	●	—	●
FX1N-24MR-ES/UL	●	●	●	●	—	●	●	—	●
FX1N-24MT-DSS	●	○	●	●	—	●	●	—	●
FX1N-40MR-DS	●	●	●	●	—	●	●	—	●
FX1N-40MR-ES/UL	●	●	●	●	—	●	●	—	●
FX1N-40MT-DSS	●	○	●	●	—	●	●	—	●
FX1N-60MR-DS	●	●	●	●	—	●	●	—	●
FX1N-60MR-ES/UL	●	●	●	●	—	●	●	—	●
FX1N-60MT-DSS	●	○	●	●	—	●	●	—	●
FX2N Base Units									
FX2N-16MR-DS	●	●	●	●	●	—	●	—	—
FX2N-16MR-ES/UL	●	●	●	●	●	●	●	●	●
FX2N-16MT-DSS	●	○	●	●	●	—	●	—	—
FX2N-16MT-ESS/UL	●	●	●	●	●	●	●	●	●
FX2N-32MR-DS	●	●	●	●	●	—	●	—	—
FX2N-32MR-ES/UL	●	●	●	●	●	●	●	●	●
FX2N-32MT-DSS	●	○	●	●	●	—	●	—	—
FX2N-32MT-ESS/UL	●	●	●	●	●	●	●	●	●
FX2N-48MR-DS	●	●	●	●	●	—	●	—	—
FX2N-48MR-ES/UL	●	●	●	●	●	●	●	●	●
FX2N-48MT-ESS/UL	●	●	●	●	●	●	●	●	●
FX2N-48MT-DSS	●	○	●	●	●	—	●	—	—
FX2N-64MR-DS	●	●	●	●	●	—	●	—	—
FX2N-64MR-ES/UL	●	●	●	●	●	●	●	●	●
FX2N-64MT-ESS/UL	●	●	●	●	●	●	●	●	●

Module type	CE		uL cUL	Ship approvals					
	EMC	LVD		ABS	DNV	LR	GL	BV	RINA
FX2N-64MT-DSS	●	○	●	●	●	—	●	—	—
FX2N-80MR-DS	●	●	●	●	●	—	●	—	—
FX2N-80MR-ES/UL	●	●	●	●	●	●	●	●	●
FX2N-80MT-DSS	●	○	●	●	●	—	●	—	—
FX2N-80MT-ESS/UL	●	●	●	●	●	●	●	●	●
FX2N-128MR-ES/UL	●	●	●	●	●	●	●	●	●
FX2N-128MT-ESS/UL	●	●	●	●	●	●	●	●	●
FX2NC Base Units									
FX2NC-16MT-DSS	●	○	●	—	●	—	—	—	—
FX2NC-16MR-T-DS	●	●	●	—	●	—	—	—	—
FX2NC-32MT-DSS	●	○	●	—	●	—	—	—	—
FX2NC-64MT-DSS	●	○	●	—	●	—	—	—	—
FX2NC-96MT-DSS	●	○	●	—	●	—	—	—	—
FX3U Base Units									
FX3U-16MR/ES	●	●	●	—	—	—	—	—	—
FX3U-32MR/ES	●	●	●	—	—	—	—	—	—
FX3U-48MR/ES	●	●	●	—	—	—	—	—	—
FX3U-64MR/ES	●	●	●	—	—	—	—	—	—
FX3U-80MR/ES	●	●	●	—	—	—	—	—	—
FX0N/FX2N Extension Units									
FX0N-40ER-ES/UL	●	●	●	—	●	—	—	—	—
FX0N-40ER-DS	●	●	—	—	●	—	—	—	—
FX0N-40ET-DSS	●	○	—	—	●	—	—	—	—
FX2N-32ER-ES/UL	●	●	●	●	●	●	●	●	●
FX2N-32ET-ESS/UL	●	●	●	●	●	●	●	●	●
FX2N-48ER-DS	●	●	●	●	●	—	—	—	—
FX2N-48ER-ES/UL	●	●	●	●	●	●	●	●	●
FX2N-48ET-DSS	●	○	●	●	●	—	—	—	●
FX2N-48ET-ESS/UL	●	●	●	●	●	●	●	●	●
FX2N Extension Blocks									
FX2N-8ER-ES/UL	●	●	●	—	—	—	—	—	—
FX2N-8EX-ES/UL	●	○	●	—	—	—	—	—	—
FX2N-8EYR-ES/UL	●	●	●	—	—	—	—	—	—
FX2N-8EYT-ESS/UL	●	○	●	—	—	—	—	—	—
FX2N-16EX-ES/UL	●	○	●	●	●	●	●	●	●
FX2N-16EYR-ES/UL	●	●	●	●	●	●	●	●	●
FX2N-16EYT-ESS/UL	●	○	●	●	●	●	●	●	●
FX2NC Extension Blocks									
FX2NC-16EX-T-DS	●	●	●	—	●	—	—	—	—
FX2NC-16EYR-T-DS	●	●	●	—	●	—	—	—	—
FX2NC-16EX-DS	●	●	●	—	●	—	—	—	—
FX2NC-16EYT-DSS	●	●	●	—	●	—	—	—	—
FX2NC-32EX-DS	●	●	●	—	●	—	—	—	—
FX2NC-32EYT-DSS	●	●	●	—	●	—	—	—	—
FX1N/FX2N Special Function Modules									
FX0N-3A	●	—	—	—	—	—	—	—	—
FX0N-32NT-DP	●	○	●	—	●	—	—	—	—
FX2N-1HC	●	●	●	●	●	●	●	●	●
FX2N-1PG-E	●	●	●	●	●	●	●	●	●
FX2N-2AD	●	○	●	●	—	—	—	—	—
FX2N-2DA	●	○	●	●	—	—	—	—	—
FX2N-2LC	●	○	●	—	—	—	—	—	—
FX2N-4AD	●	○	●	●	●	●	●	●	●
FX2N-4AD-TC	●	○	●	●	●	●	●	●	●
FX2N-4AD-PT	●	○	●	●	●	●	●	●	●
FX2N-4DA	●	○	●	—	—	—	—	—	●
FX2N-5A	●	○	●	—	—	—	—	—	●
FX2N-8AD	●	○	●	—	—	—	●	—	●

● = comply, ○ = no need to comply

Module type	CE		uL cUL	Ship approvals					
	EMC	LVD		ABS	DNV	LR	GL	BV	RINA
FX2N-10PG	●	○	●	—	—	—	—	—	—
FX2N-16CCL-M	●	○	—	—	—	—	—	—	—
FX2N-32ASI-M	●	○	—	—	—	—	—	—	—
FX2N-32CAN	●	○	—	—	—	—	—	—	—
FX2N-32CCL	●	○	—	—	—	—	—	—	—
FX2N-32DP-IF	●	●	●	—	●	—	—	—	—
FX2N-64DNET	●	○	●	—	—	—	—	—	—
FX2N-232IF	●	○	—	●	●	●	●	●	●
FX2NC Special Function Modules									
FX2NC-4DA	●	○	●	—	—	—	—	—	—
FX2NC-4AD	●	○	●	—	—	—	—	—	—
FX2NC-485ADP	●	—	—	—	—	—	—	—	—
FX2NC-232ADP	●	—	—	—	—	—	—	—	—
FX2NC-ENET-ADP	●	○	●	—	—	—	—	—	—
FX3U Special Function Modules									
FX3U-4AD-TC-ADP	●	○	●	—	—	—	—	—	—
FX3U-4AD-PT-ADP	●	○	●	—	—	—	—	—	—
FX3U-4AD-ADP	●	○	●	—	—	—	—	—	—
FX3U-4DA-ADP	●	○	●	—	—	—	—	—	—
FX3U-4HSX-ADP	●	○	●	—	—	—	—	—	—
FX3U-2HSY-ADP	●	○	●	—	—	—	—	—	—
FX3U-485ADP	●	○	●	—	—	—	—	—	—
FX3U-232ADP	●	○	●	—	—	—	—	—	—
FX3U-ENET	●	○	●	—	—	—	—	—	—
FX3U-64DP-M	●	○	●	—	—	—	—	—	—
Adapter Boards									
FX1N-1DA-BD	●	○	—	●	●	●	●	—	●
FX1N-2AD-BD	●	○	—	●	●	●	●	—	●
FX1N-2EYT-BD	●	○	—	●	●	●	●	—	●
FX1N-4EX-BD	●	○	—	●	●	●	●	—	●
FX1N-8AV-BD	●	○	—	●	●	●	●	—	●
FX1N-232-BD	●	○	—	●	—	●	●	—	●
FX1N-422-BD	●	○	—	●	—	●	●	—	●
FX1N-485-BD	●	○	—	●	—	●	●	—	●
FX1N-CNV-BD	●	○	—	●	●	●	—	—	—
FX2N-8AV-BD	●	○	—	●	—	—	—	—	—
FX2N-232-BD	●	○	—	●	—	—	—	—	—
FX2N-422-BD	●	○	—	●	—	—	—	—	—
FX2N-485-BD	●	○	—	●	—	—	—	—	—
FX2N-CNV-BD	●	○	—	—	—	—	—	—	—
FX3U-232-BD	●	○	—	—	—	—	—	—	—
FX3U-422-BD	●	○	—	—	—	—	—	—	—
FX3U-485-BD	●	○	—	—	—	—	—	—	—
FX3U-CNV-BD	●	○	—	—	—	—	—	—	—
FX3U-USB-BD	●	○	—	—	—	—	—	—	—

Module type	CE		uL cUL	Ship approvals					
	EMC	LVD		ABS	DNV	LR	GL	BV	RINA
Terminal Blocks									
TB-8EX-S	—	○	●	—	—	—	—	—	—
TB-8EX-C	—	○	●	—	—	—	—	—	—
TB-8EX-S	—	○	●	—	—	—	—	—	—
TB-16EX-C	—	○	●	—	—	—	—	—	—
TB-8EY-S	—	○	●	—	—	—	—	—	—
TB-8EY-C	—	○	●	—	—	—	—	—	—
TB-20S	—	○	●	—	—	—	—	—	—
TB-20C	—	○	●	—	—	—	—	—	—
TB-8RELAY-6A	—	—	—	—	—	—	—	—	—
TB-8TRANSISTOR-2A	—	○	●	—	—	—	—	—	—
TB-CON10-C	—	○	●	—	—	—	—	—	—
TB-CON-11C	—	○	●	—	—	—	—	—	—
Accessories									
ALPHA POWER 24	●	●	—	—	—	—	—	—	—
FX1N-5DM	●	○	—	●	●	●	●	—	●
FX-10DM-E	●	○	—	—	—	—	—	—	—
FX-20 P-E-SET0	●	○	—	—	—	—	—	—	—
FX-USB-AW	●	○	—	—	—	—	—	—	—
FX-232AWC-H	●	○	—	—	—	—	—	—	—
FX2N-CNV-IF	●	○	—	●	—	—	—	—	—
FX2N-CNV-BC	●	○	—	—	—	—	—	—	—
FX2N-20PSU	●	●	—	—	—	—	—	—	—
FX2NC-CNV-IF	●	○	—	—	—	—	—	—	—
FX3U-7DM	●	○	—	—	—	—	—	—	—
FX3U-7DM-HLD	●	—	—	—	—	—	—	—	—

● = comply, ○ = no need to comply

Accessories	FX1N-60MT-DSS	17	FX2N-80MT-DSS	21	GX IEC Developer	83
24 V Power Supply Unit	FX1N-8AV-BD	47	FX2N-80MT-ESS/UL	21	GX IEC Developer FX	83
Batteries	FX1N-CNV-BD	44, 47	FX2N-8AD	33	High speed counter	36
Cables	FX1N-EEPROM-8L	49	FX2N-8AV-BD	47	Interface modules	45
Display modules	FX1S series		FX2N-8ER-ES/UL	31	Network modules	38
Hand-held programming unit	Base units	14	FX2N-8EX-ES/UL	31	Positioning modules	37
Interface cables	Specifications	15	FX2N-8EYR-ES/UL	31	Sample Calculations	7
Memory media	System description	13	FX2N-8EYT-ESS/UL	31	SC-09	85
ALPHA 2 series	FX1S-10MR-DS	14	FX2NC series		Software	
FX series	FX1S-10MR-ES/UL	14	Base units	24	AL-PCS/WIN	82
Adapter boards	FX1S-10MT-DSS	14	Specifications	25	FX-TRN-BEG-E	82
AL2-10MR-A	FX1S-14MR-DS	14	System description	23	GX Configurator DP	84
AL2-10MR-D	FX1S-14MR-ES/UL	14	FX2NC-16EX-DS	32	GX Developer	83
AL2-14MR-A	FX1S-14MT-DSS	14	FX2NC-16EX-T-DS	32	GX IEC Developer	83
AL2-14MR-D	FX1S-20MR-DS	14	FX2NC-16EYR-T-DS	32	Specifications	
AL2-24MR-A	FX1S-20MR-ES/UL	14	FX2NC-16EYT-DSS	32	ALPHA 2	9
AL2-24MR-D	FX1S-20MT-DSS	14	FX2NC-16MR-T-DS	24	FX1N series	18
AL2-2DA	FX1S-30MR-DS	14	FX2NC-16MT-DSS	24	FX1S series	15
AL2-2PT-ADP	FX1S-30MR-ES/UL	14	FX2NC-232ADP	45	FX2N series	22
AL2-2TC-ADP	FX1S-30MT-DSS	14	FX2NC-32BL	52	FX2NC series	25
AL-232CAB	FX-20 P-E-SET0	85	FX2NC-32EX-DS	32	FX3U series	28
AL2-4EX	FX-20P-CAB	52	FX2NC-32EYT-DSS	32	System description	
AL2-4EX-A2	FX-20P-CAB0	52	FX2NC-32MT-DSS	24	ALPHA 2 series	8
AL2-4EYR	FX-20P-CADP	52	FX2NC-485ADP	44	FX1N series	16
AL2-4EYT	FX-232AWC-H	52	FX2NC-4AD	33	FX1S series	13
AL2-ASI-BD	FX-232CAB-1	52	FX2NC-4DA	33	FX2N series	19
AL2-EEPROM-2	FX2N series		FX2NC-64MT-DSS	24	FX2NC series	23
AL2-GSM-CAB	Base units	20	FX2NC-96MT-DSS	24	FX3U series	26
AL-PCS/WIN	Specifications	22	FX2NC-CNV-IF	44	MELSEC PLC Systems	4
ALPHA 2 series	System description	19	FX2NC-EEPROM-16	49	TB-16EX-C	50
Accessories	FX2N-10PG	37	FX2NC-EEPROM16C	49	TB-16EX-S	50
Base units	FX2N-128MR-ES/UL	21	FX2NC-EEPROM-4C	49	TB-20C	50
Extension modules	FX2N-128MT-ESS/UL	21	FX2NC-ENET-ADP	40	TB-20-S	50
Interface cable	FX2N-16CCL-M	38	FX2N-CNV-BD	44, 47	TB-8EX-C	50
Memory cassette	FX2N-16EX-ES/UL	31	FX2N-CNV-IF	44	TB-8EX-S	50
Specifications	FX2N-16EYR-ES/UL	31	FX2NC-ROM-CE1	49	TB-8EY-C	50
System description	FX2N-16EYT-ESS/UL	31	FX2NC-RTC	49	TB-8EY-S	50
ALPHA POWER 24-1,4	FX2N-16MR-DS	20	FX2N-ROM-E1	49	TB-8RELAY-6A	50
Analog modules FX series	FX2N-16MR-ES/UL	20	FX3U series		TB-8TRANSISTOR-2A	50
approvals	FX2N-16MT-DSS	20	Base units	27	TB-CON10-C	51
Cables	FX2N-16MT-ESS/UL	20	Specifications	28	TB-CON-11C	51
Communication adapters	FX2N-1HC	36	System description	26	TB-EX-CAB-1M	51
Dimensions	FX2N-1PG-E	37	FX3U-16MR/ES	27	TB-EX-CAB-3M	51
Display modules	FX2N-232-BD	48	FX3U-232ADP	45	TB-EX-CAB-5M	51
Extension adapters FX series	FX2N-232IF	45	FX3U-232-BD	48	TB-EY-CAB-1M	51
Extensions	FX2N-2AD	33	FX3U-2HSY-ADP	36	TB-EY-CAB-3M	51
ALPHA 2 Series	FX2N-2DA	33	FX3U-32BL	52	TB-EY-CAB-5M	51
FX0N/FX2N series	FX2N-2LC	34	FX3U-32MR/ES	27	Terminal blocks	50
F2-232CAB-1	FX2N-32ASI-M	39	FX3U-422-BD	48	Terminal Layouts	55
F2-4OBL	FX2N-32CAN	43	FX3U-485ADP	44		
F2-RS-5CAB	FX2N-32CCL	38	FX3U-485-BD	48		
FX0N-32NT-DP	FX2N-32DP-IF	42	FX3U-48MR/ES	27		
FX0N-3A	FX2N-32DP-IF-D	42	FX3U-4AD-ADP	35		
FX0N-40ER-DS	FX2N-32ER-ES/UL	30	FX3U-4AD-PT-ADP	35		
FX0N-40ER-ES/UL	FX2N-32ET-ESS/UL	30	FX3U-4AD-TC-ADP	35		
FX0N-40ET-DSS	FX2N-32MR-DS	20	FX3U-4DA-ADP	35		
FX0N-65EC	FX2N-32MR-ES/UL	20	FX3U-4HSX-ADP	36		
FX-10DM-E	FX2N-32MT-DSS	20	FX3U-64DP-M	41		
FX1N series	FX2N-32MT-ESS/UL	20	FX3U-64MR/ES	27		
Base units	FX2N-422-BD	48	FX3U-7DM	53		
Specifications	FX2N-485-BD	48	FX3U-7DM-HLD	53		
System description	FX2N-48ER-DS	30	FX3U-80MR/ES	27		
FX1N-14MR-DS	FX2N-48ER-ES/UL	30	FX3U-CNV-BD	47		
FX1N-14MR-ES/UL	FX2N-48ET-DSS	30	FX3U-ENET	40		
FX1N-14MT-DSS	FX2N-48ET-ESS/UL	30	FX3U-FLROM-16	49		
FX1N-1DA-BD	FX2N-48MR-DS	21	FX3U-FLROM-64	49		
FX1N-232-BD	FX2N-48MR-ES/UL	21	FX3U-FLROM-64L	49		
FX1N-24MR-DS	FX2N-48MT-DSS	21	FX3U-USB-BD	47		
FX1N-24MR-ES/UL	FX2N-48MT-ESS/UL	21	FX-422CAB	52		
FX1N-24MT-DSS	FX2N-4AD	33	FX-422CAB0	52		
FX1N-2AD-BD	FX2N-4AD-PT	34	FX-422CAB-150	52		
FX1N-2EYT-BD	FX2N-4AD-TC	34	FX-EEPROM-16	49		
FX1N-40MR-DS	FX2N-4DA	33	FX-EEPROM-4	49		
FX1N-40MR-ES/UL	FX2N-5A	34	FX-EEPROM-8	49		
FX1N-40MT-DSS	FX2N-64DNET	43	FX-EEPROM-8	49		
FX1N-422-BD	FX2N-64MR-DS	21	FX-RAM-8	49		
FX1N-485-BD	FX2N-64MR-ES/UL	21	FX-TRN-BEG-E	82		
FX1N-4EX-BD	FX2N-64MT-DSS	21	FX-USB-AW	52		
FX1N-5DM	FX2N-64MT-ESS/UL	21	GX Configurator DP	84		
FX1N-60MR-DS	FX2N-80MR-DS	21	GX Developer	83		
FX1N-60MR-ES/UL	FX2N-80MR-ES/UL	21	GX Developer FX	83		

Global Partner. Local Friend.

EUROPEAN SERVICE GROUP
MITSUBISHI ELECTRIC EUROPE B.V.
Gothaer Str. 8

D-40880 RATINGEN

Free European Hotline:

+49 (0) 1805 000 765

Training Hotline:

+49 (0) 2102 486 1880

**EUROPEAN
DEVELOPMENT CENTER**

MITSUBISHI ELECTRIC EUROPE B.V.
Gothaer Str. 8

D-40880 RATINGEN

FRANCE

MITSUBISHI ELECTRIC EUROPE B.V.
25, Boulevard des Bouvets

F-92741 NANTERRE CEDEX

Phone: +33 1 55 68 55 68

GERMANY

MITSUBISHI ELECTRIC EUROPE B.V.
Gothaer Str. 8

D-40880 RATINGEN

Phone: +49 (0) 1805 000 765
Training: +49 (0) 2102 486 1880

**Kunden-Technologie-Center
Dortmund**

Phone: +49 (0) 231 96 70 41 0

Filderstadt

Phone: +49 (0) 711 77 05 98 0

Hallbergmoos

Phone: +49 (0) 811 99 87 4 0

GREAT BRITAIN

MITSUBISHI ELECTRIC EUROPE B.V.
Travellers Lane

GB-HATFIELD HERTS. AL10 8 XB

Phone: +44 (0) 17 07 27 61 00

Training:

+44 (0) 17 07 27 89 16

**Customer Technology Centre,
Hatfield**

Phone: +44 (0) 17 07 27 89 90

**Regional Automation Center,
Wakefield**

Phone: +44 (0) 1924 255 628

IRELAND

MITSUBISHI ELECTRIC EUROPE B.V.
Irish branch, Westgate Business

Park, Ballymount

IRL-DUBLIN 24

Phone: +353 1 41 98 80 0

ITALY

MITSUBISHI ELECTRIC EUROPE B.V.
C.D. Colleoni - P.Perseo Ing. 2,
Via Paracelso 12

I-20041 AGRATE BRIANZA (MI)

Phone: +39 (0)39 / 60 53 1

SPAIN

MITSUBISHI ELECTRIC EUROPE B.V.
Carretera de Rubi 76-80

**E-08190 SANT CUGAT DEL
VALLÉS**

Phone: +34 93 56 53 13 1